

RL-81

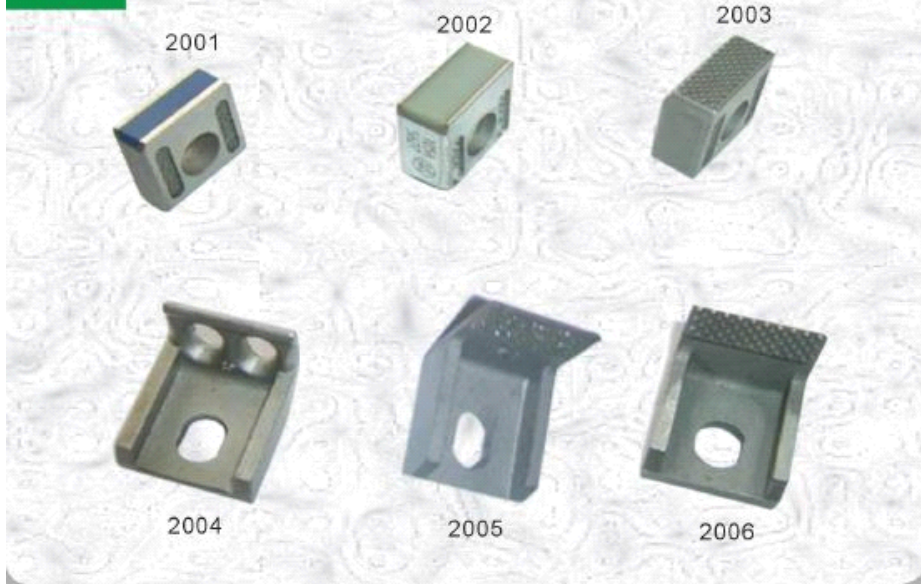

RL-82

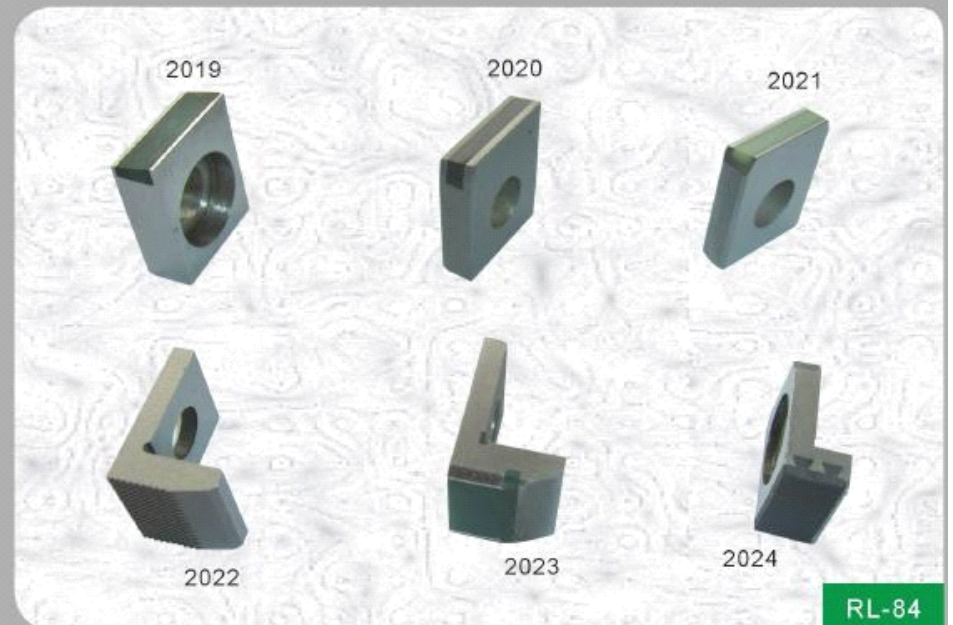
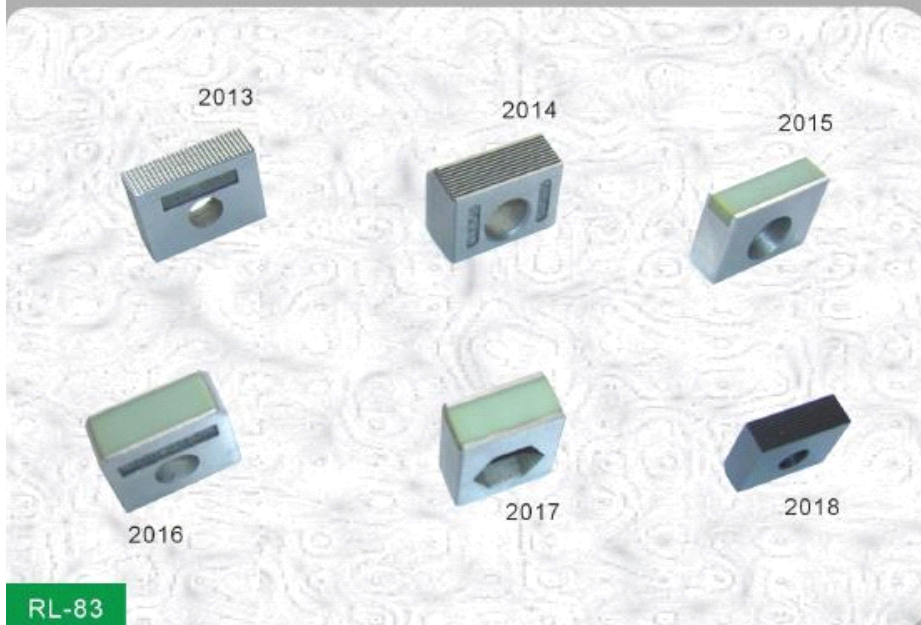
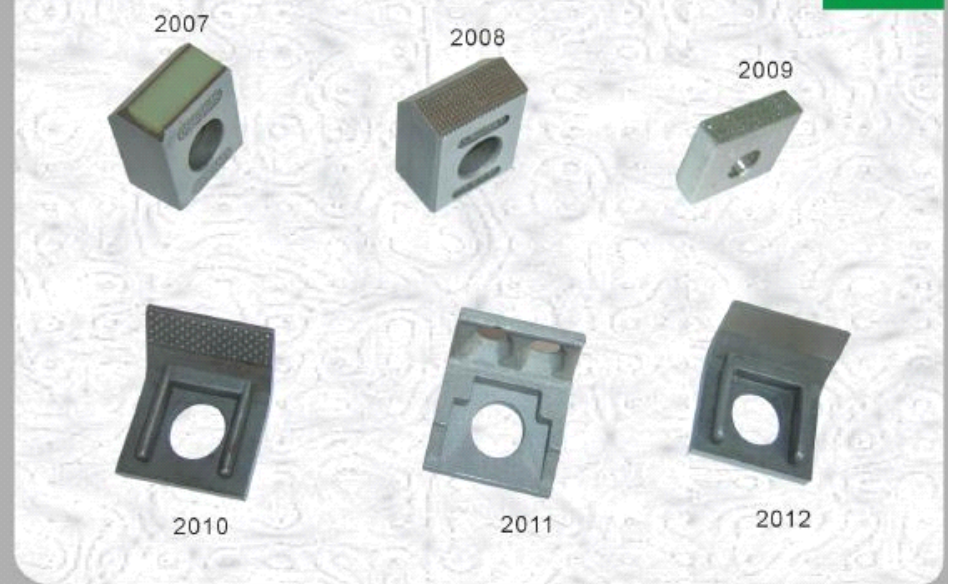

RL-85



RL-86

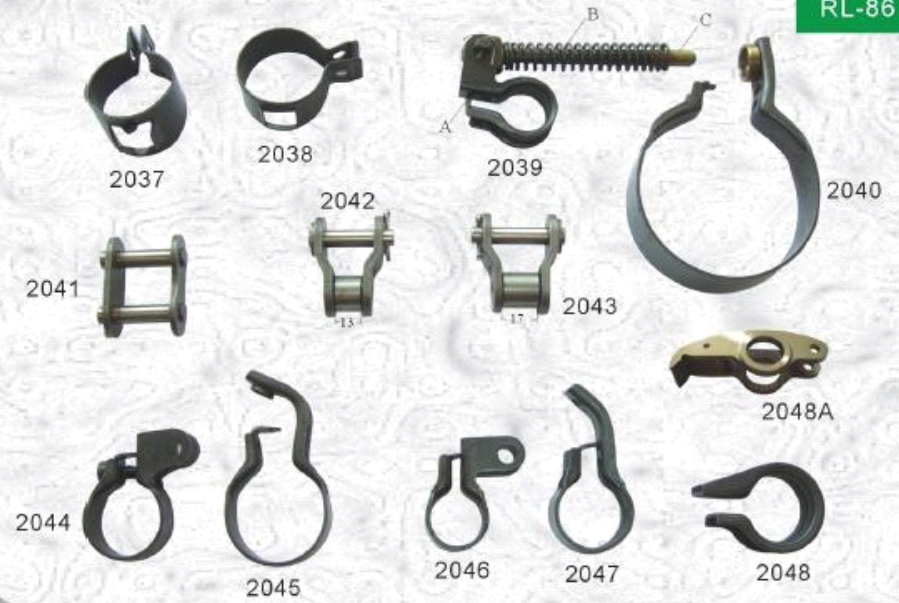

2049A



2049

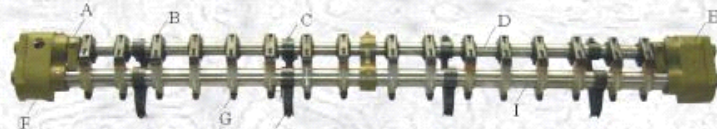

2050



2051



2052



2053



2054

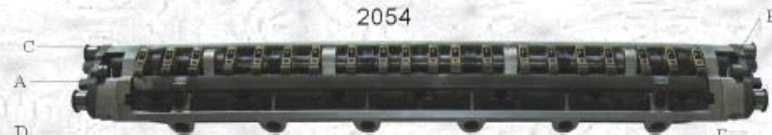

2055



2056

2057

2058

2059



RL-87

RL-88

RL-89

730×115×1.6

2060

1030×145×1.6
1030×125×1.6

2061

A

2062

φ28
φ25

2063

2064

φ28×1070

φ28×1210

2065

φ28×1180

RL-90

2066

A B

2067

2068

L=1015

2069

L=1020

2070

L=1065

RL-91

2071

2072

2073

2074

2075

2076

2077

2078

2079

2080

2081

L=708

L=970

L=1015

2082

L=720 L=750

2083

L=800

2084

2085

L=1000

2086

L=1100 L=1050

2087A

L=650, 730

2087B

L=925

2088A

2088B

2089A

2089B

L=1030, L=975, L=1280

RL-92

RL-93



RL-94



RL-95



RL-96

RL-97



RL-98



RL-99



RL-100

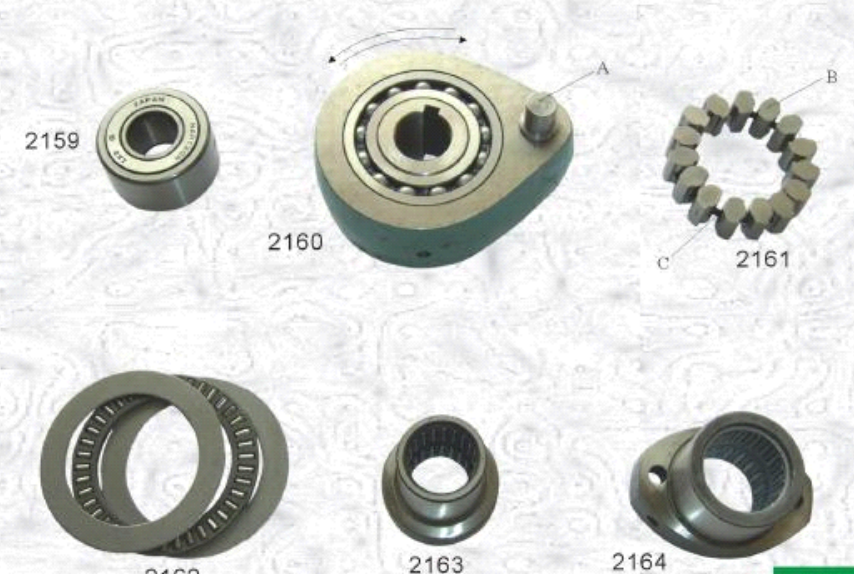

RL-101



RL-102



RL-103

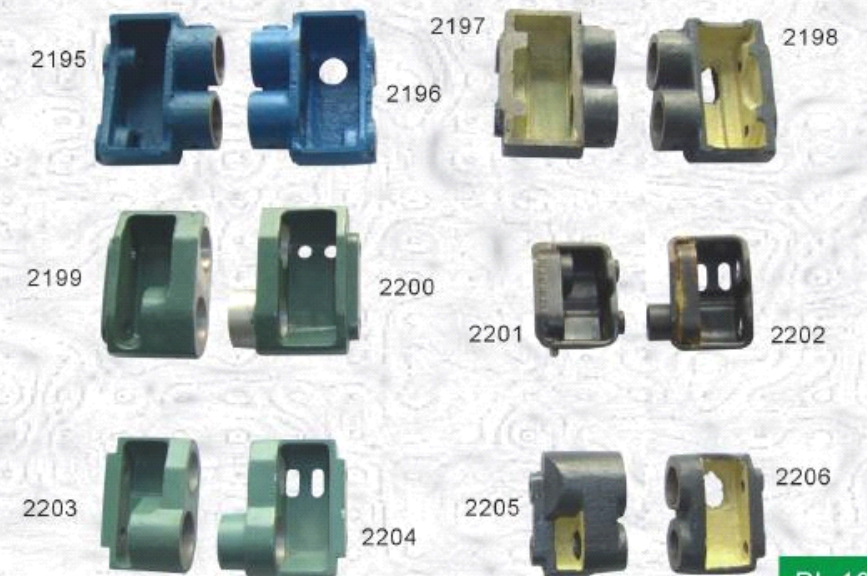

RL-104

RL-105



RL-106



RL-107

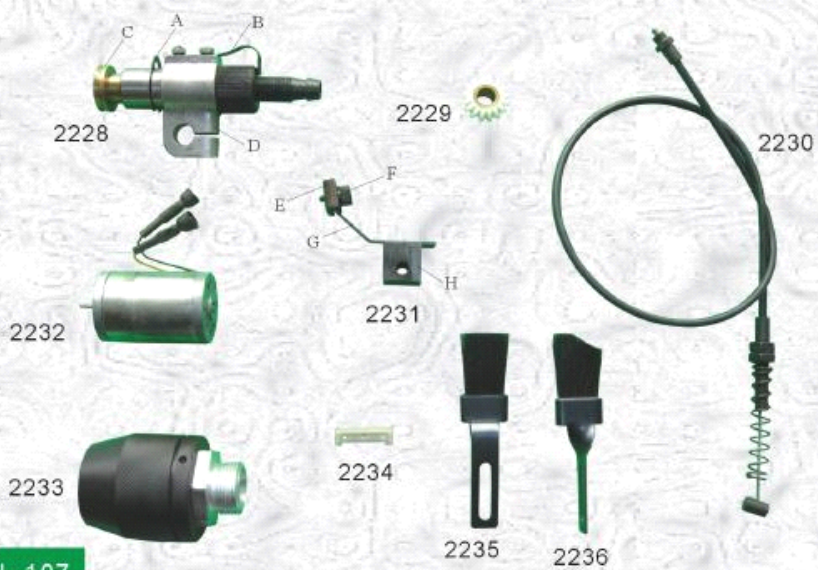

RL-108

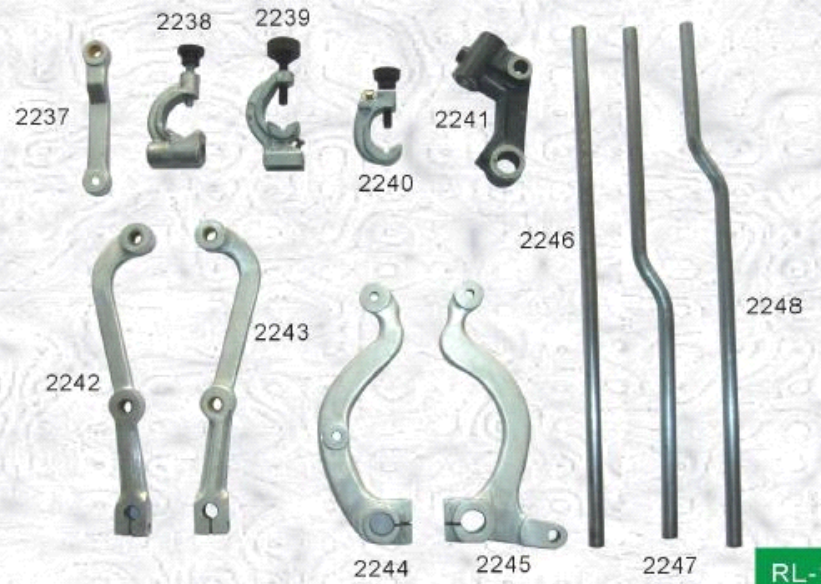

RL-109

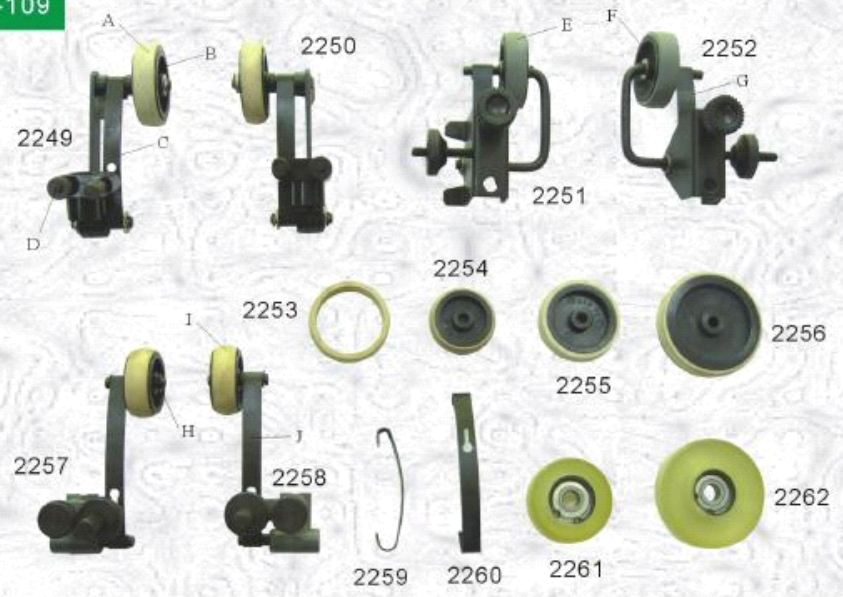

RL-110



RL-111

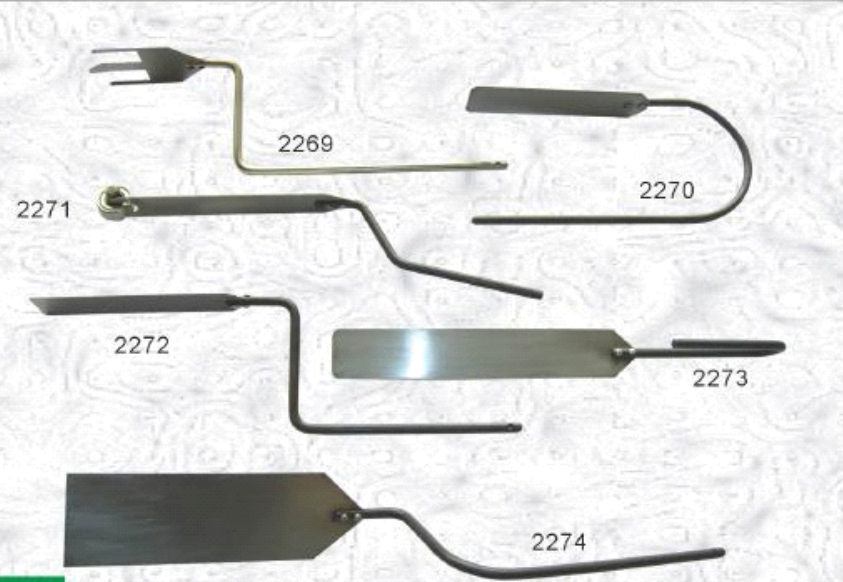

RL-112



RL-113



RL-114

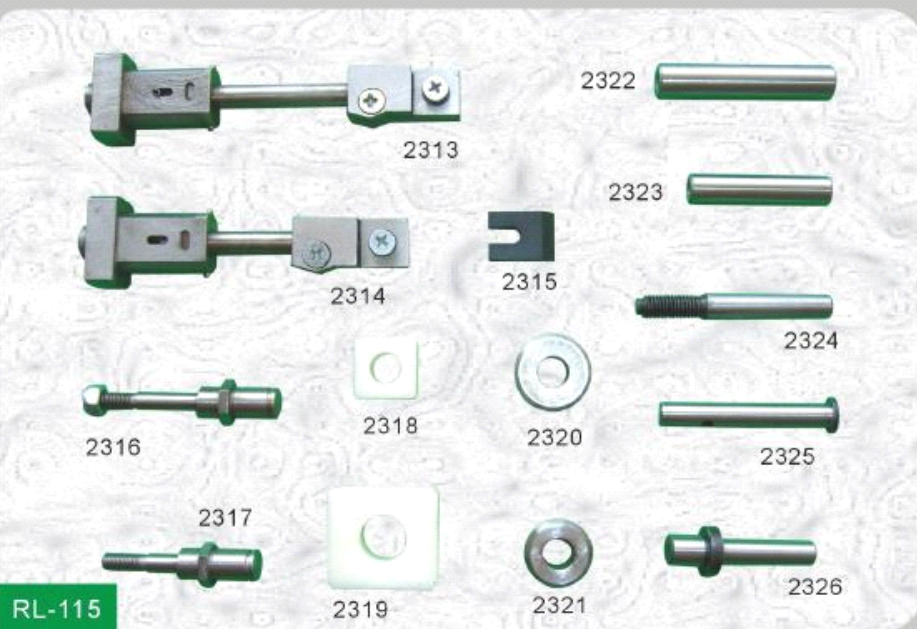

RL-115

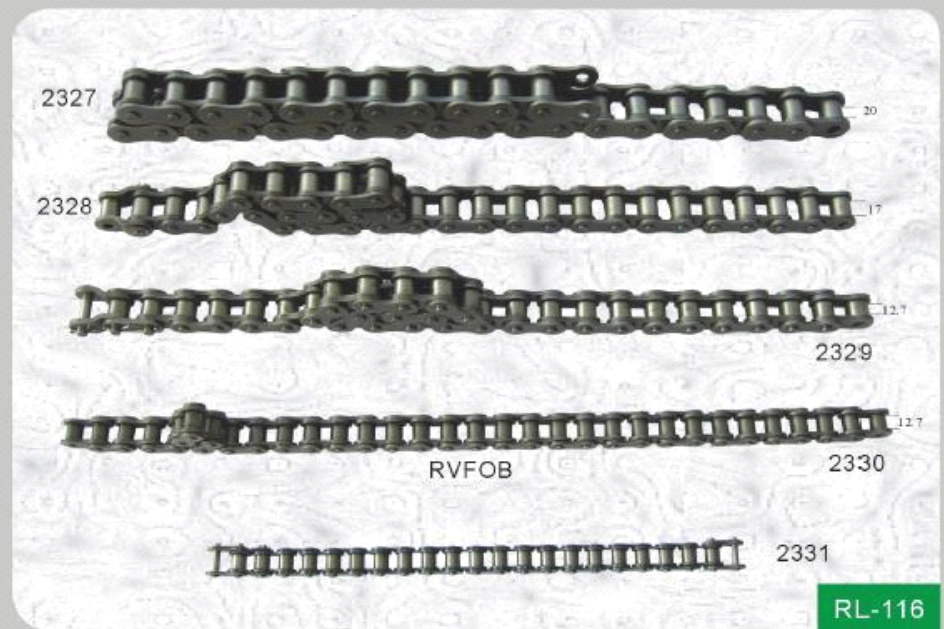

RL-116

RL-117

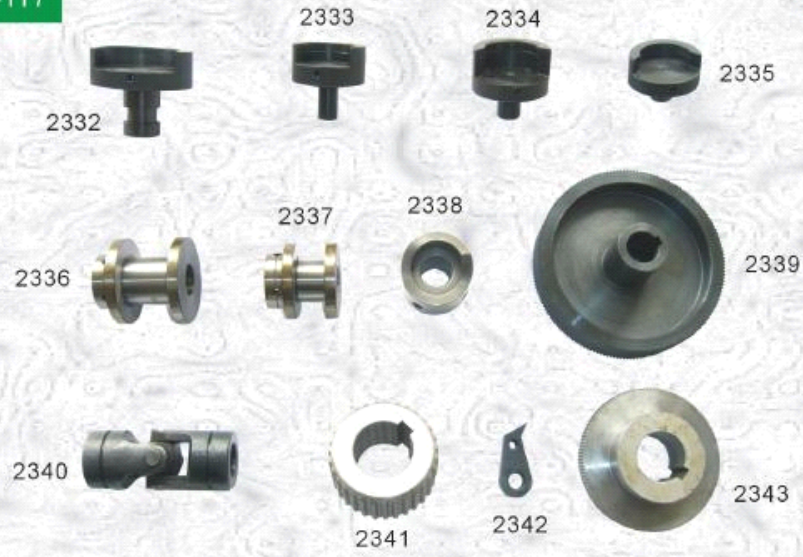

RL-118



RL-119

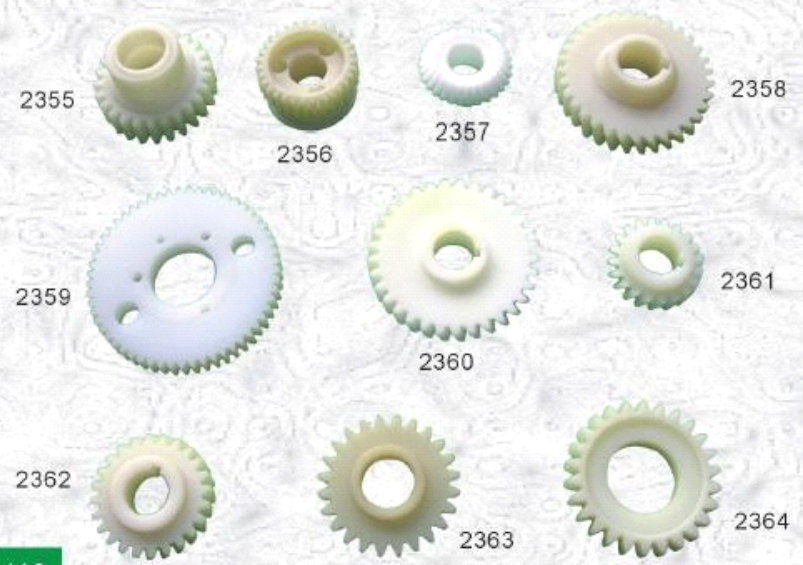

RL-120



RL-121

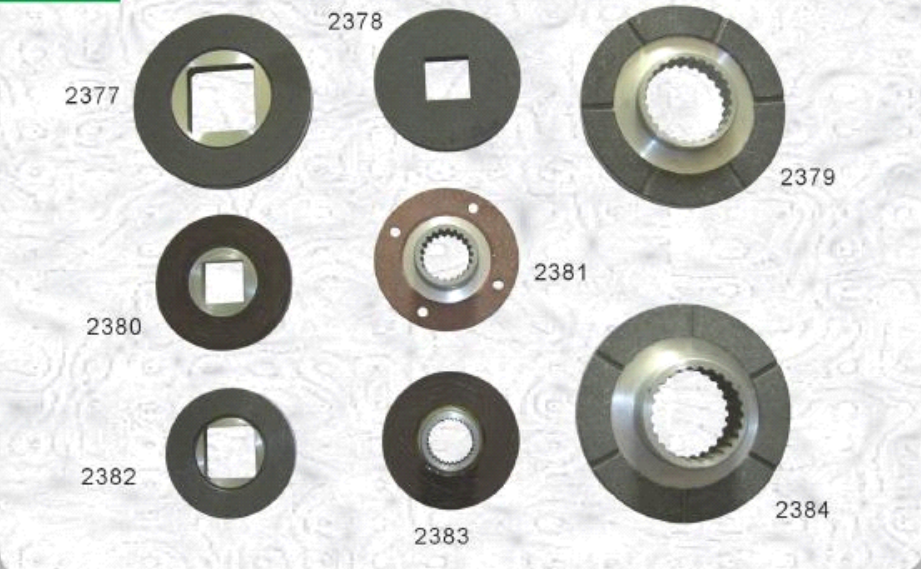

RL-122

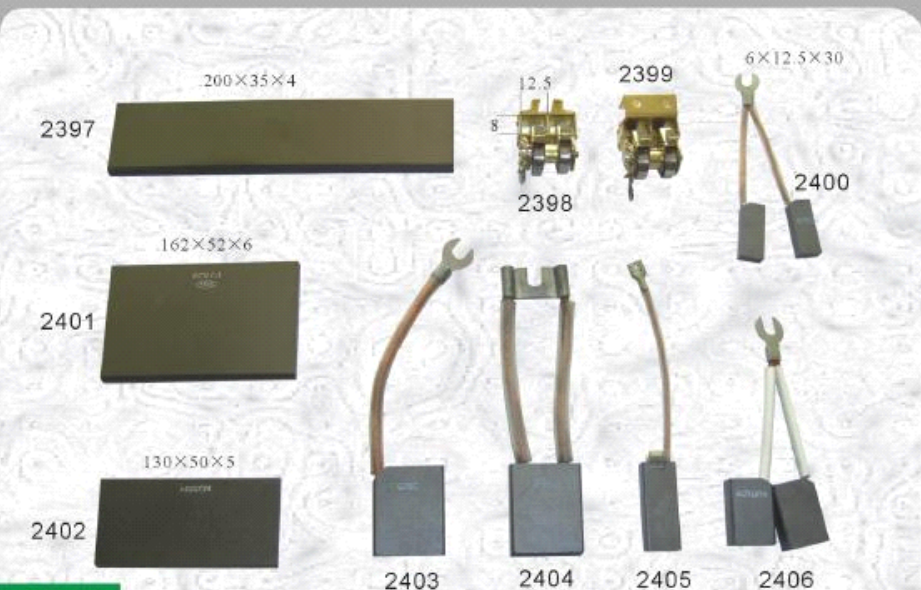
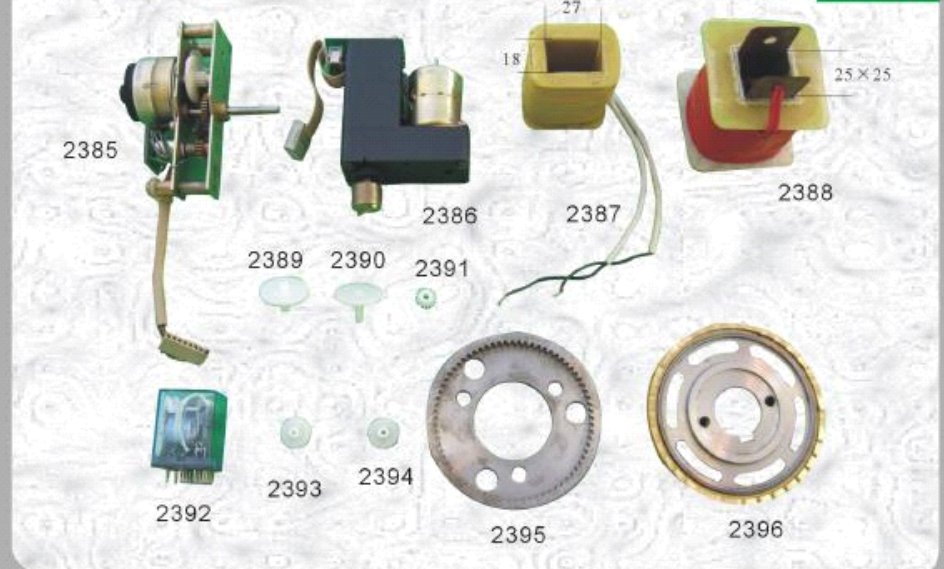

RL-123

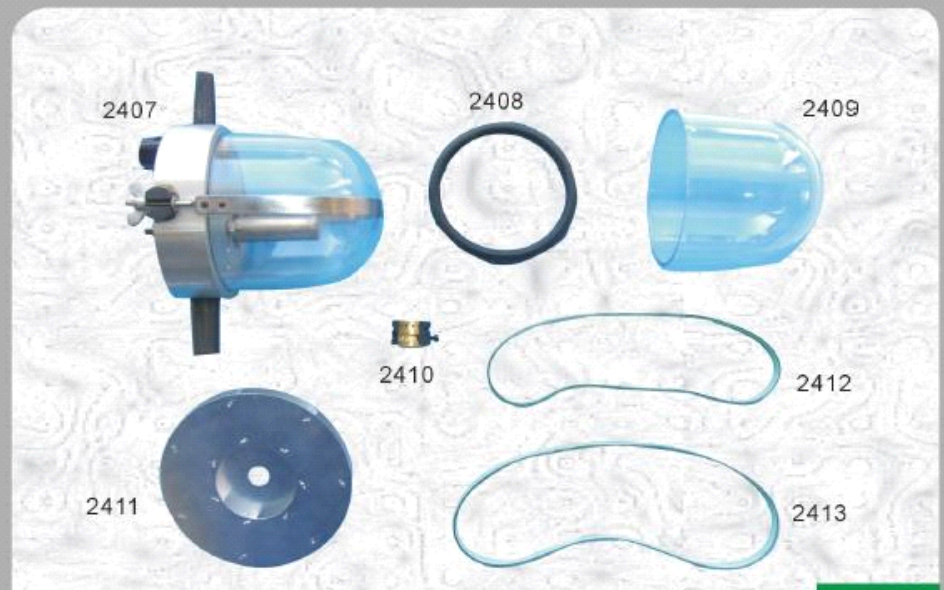

RL-124

RL-125

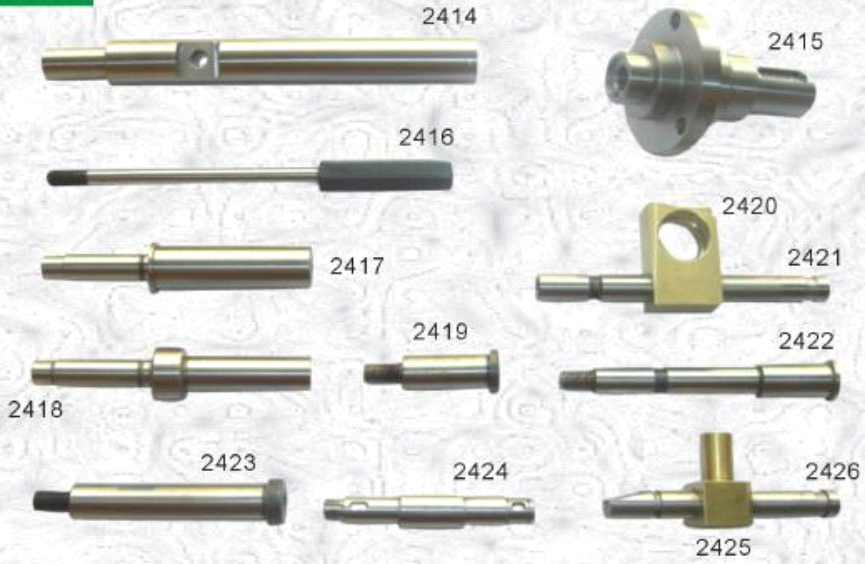

RL-126



RL-127



RL-128

RL-129



RL-130



RL-131

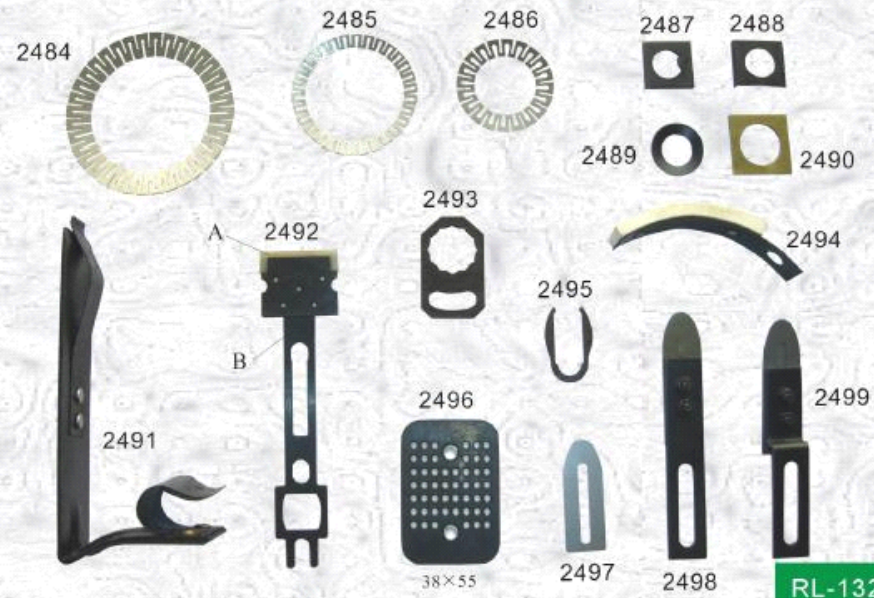

RL-132

RL-133

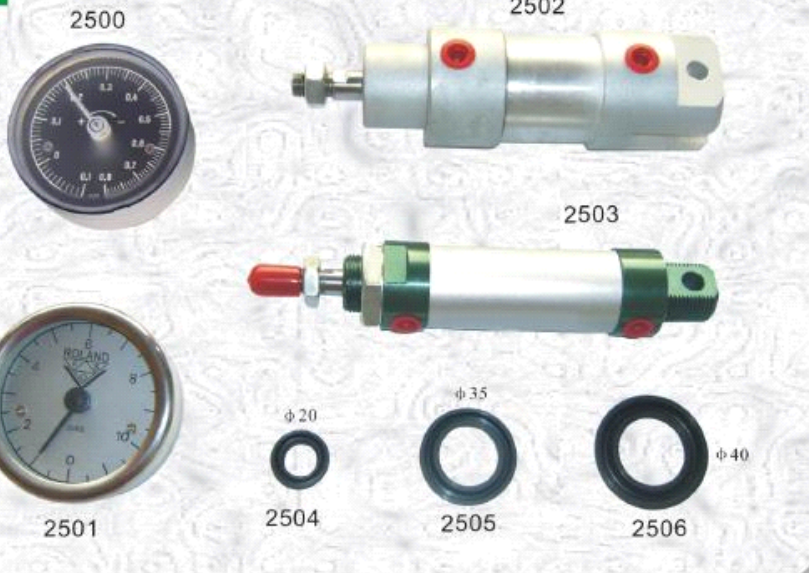

RL-134



RL-135

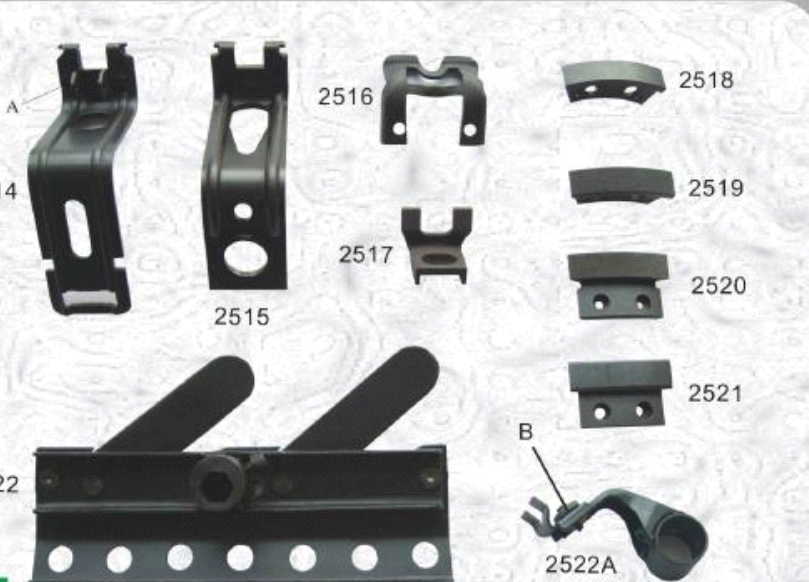

RL-136

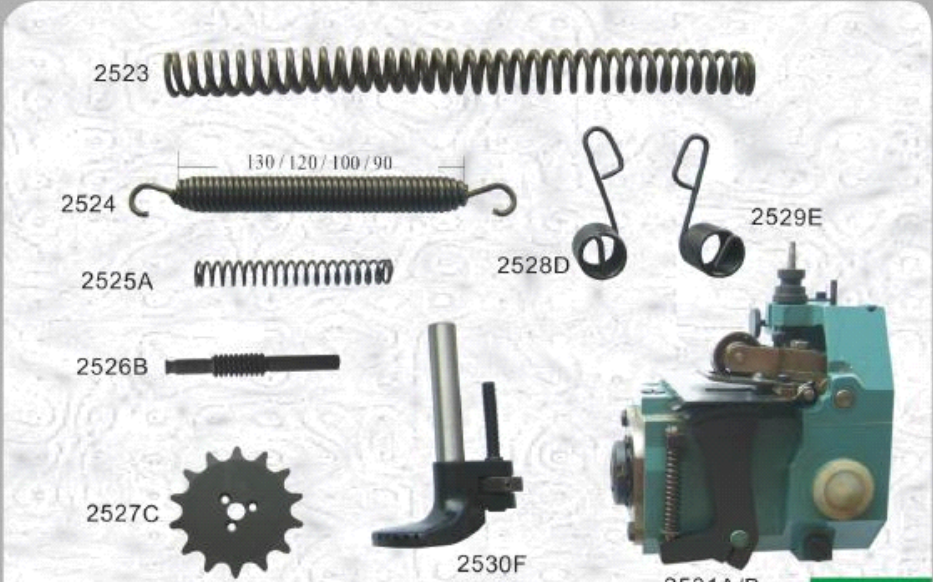

RL-137



RL-138



RL-139



RL-140



RL-141



RL-142

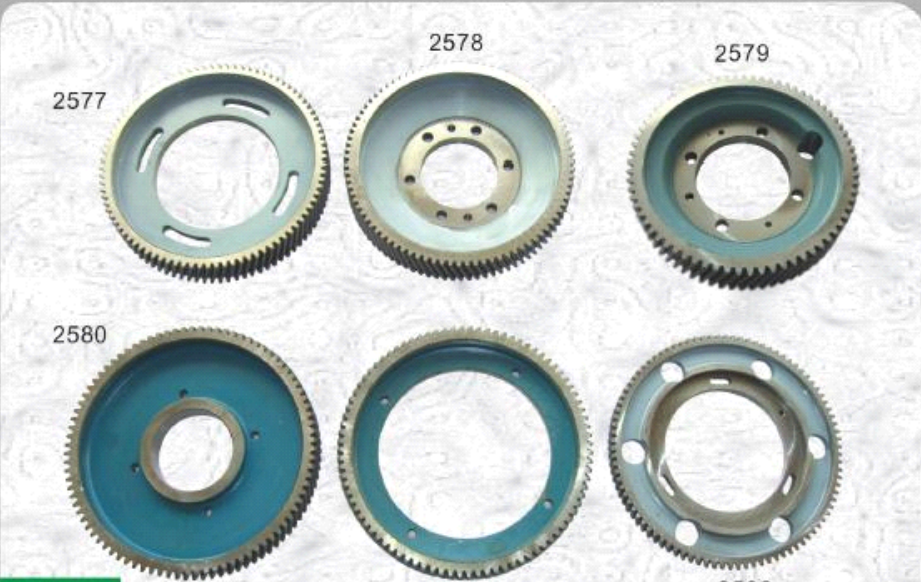
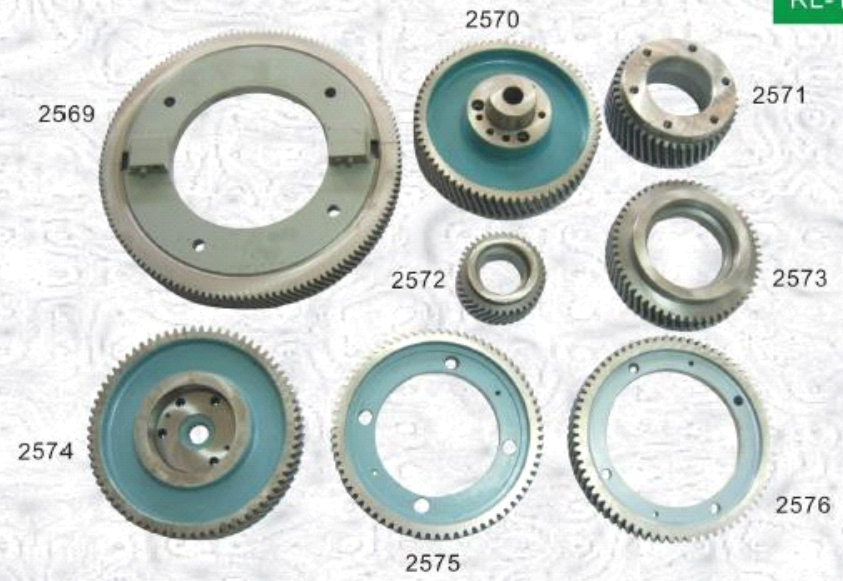

RL-143

RL-144

RL-145

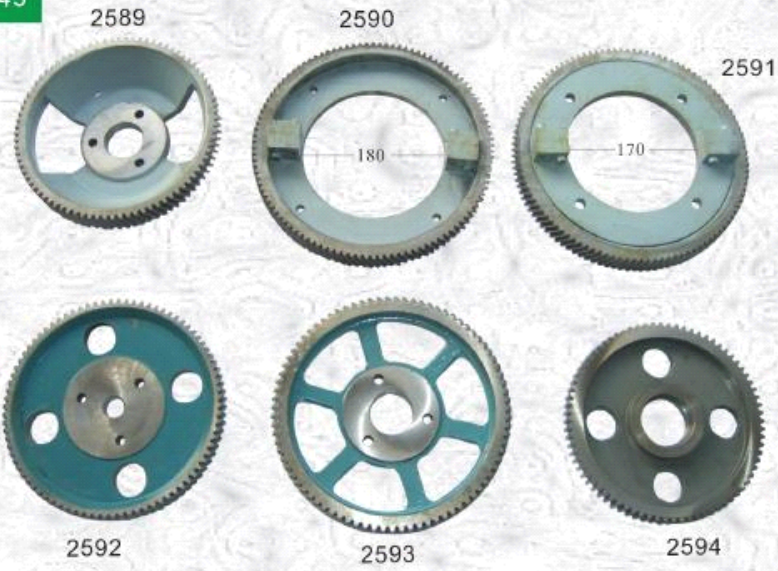

RL-146



RL-147



RL-148



RL-149



RL-150

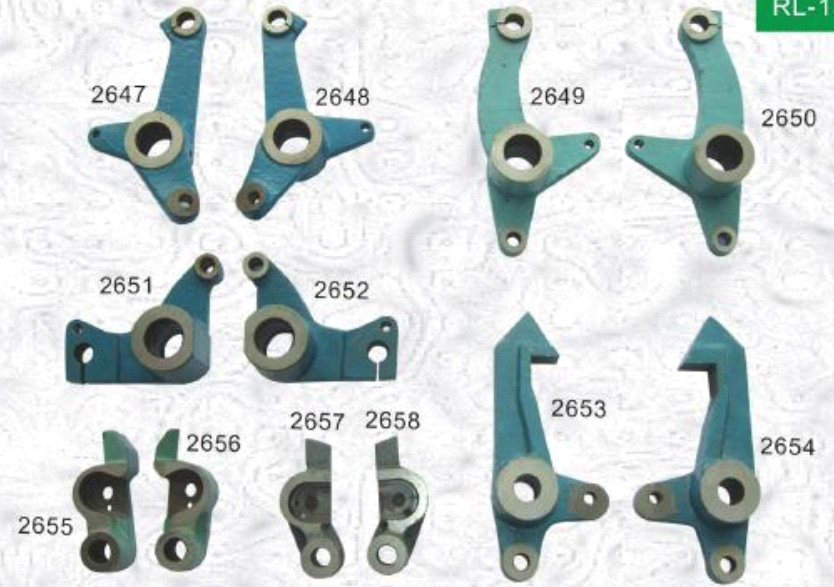

2659

2660

2661

2662

2663

2664

2665

2666

2668

2669

2667

RL-151



2670

2671

2672

2673

2674

2675

RL-152

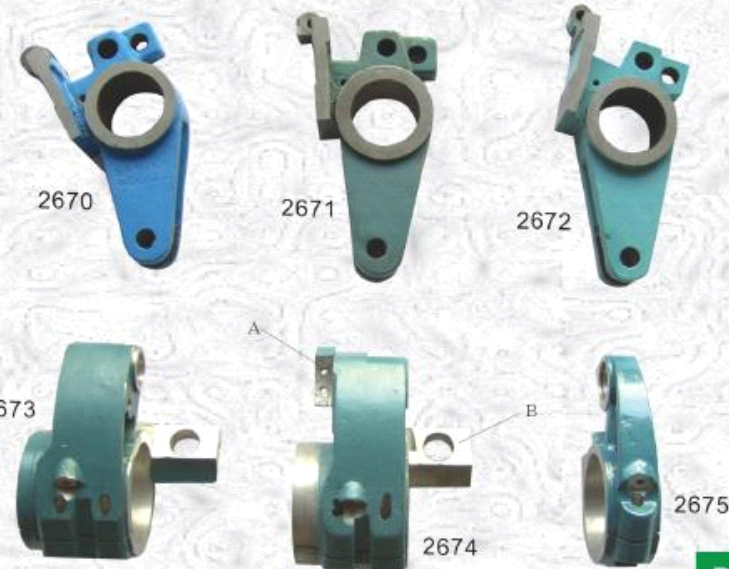

RL-153



RL-154

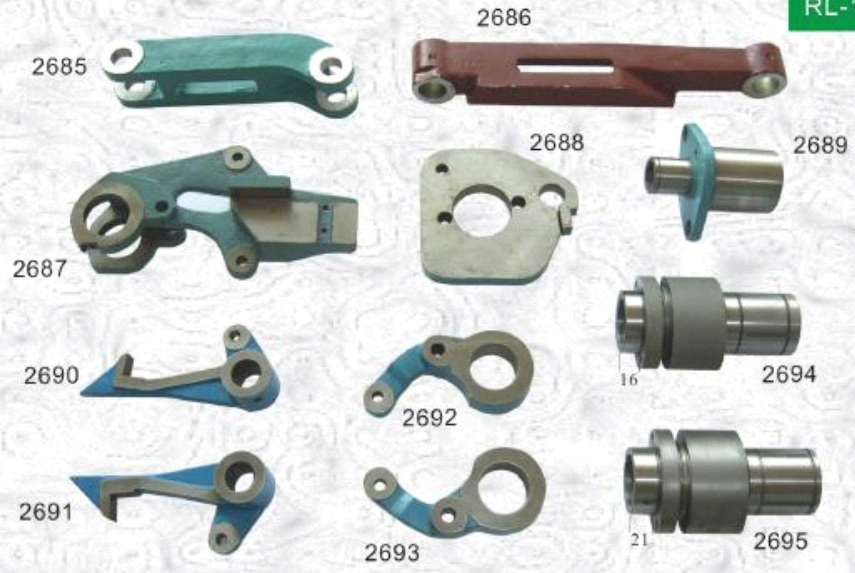

RL-155

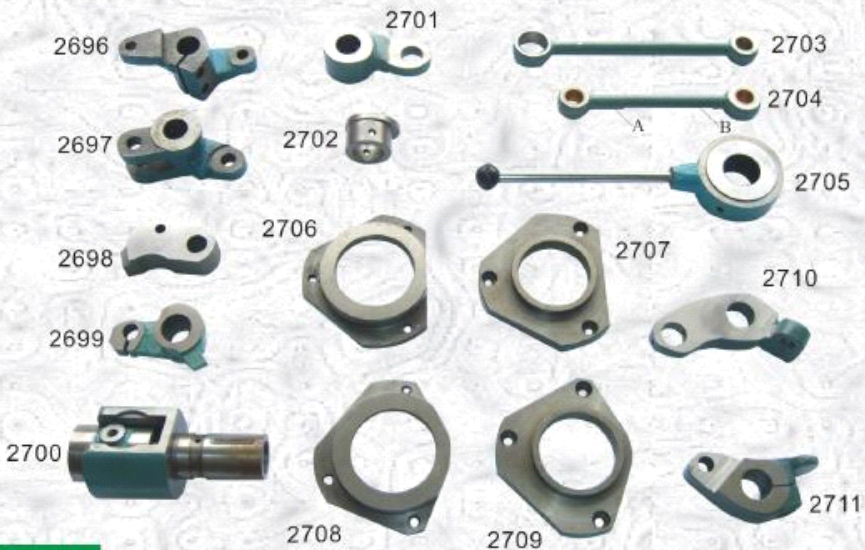

RL-156



RL-157



RL-158



RL-159

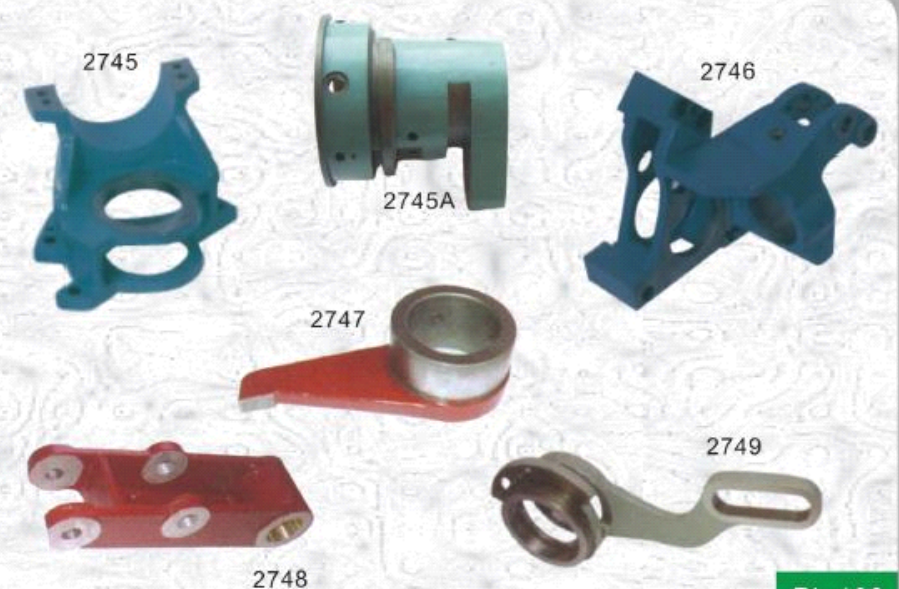

RL-160