

HB-1

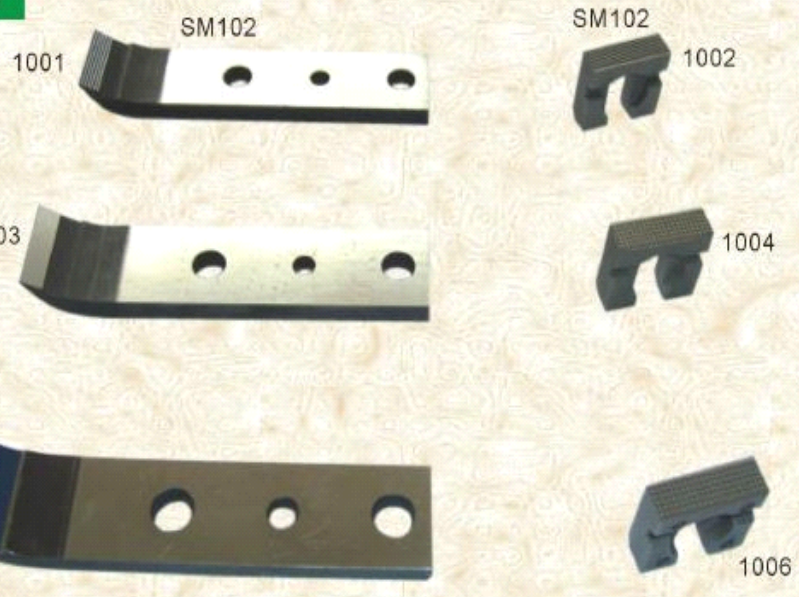

HB-2

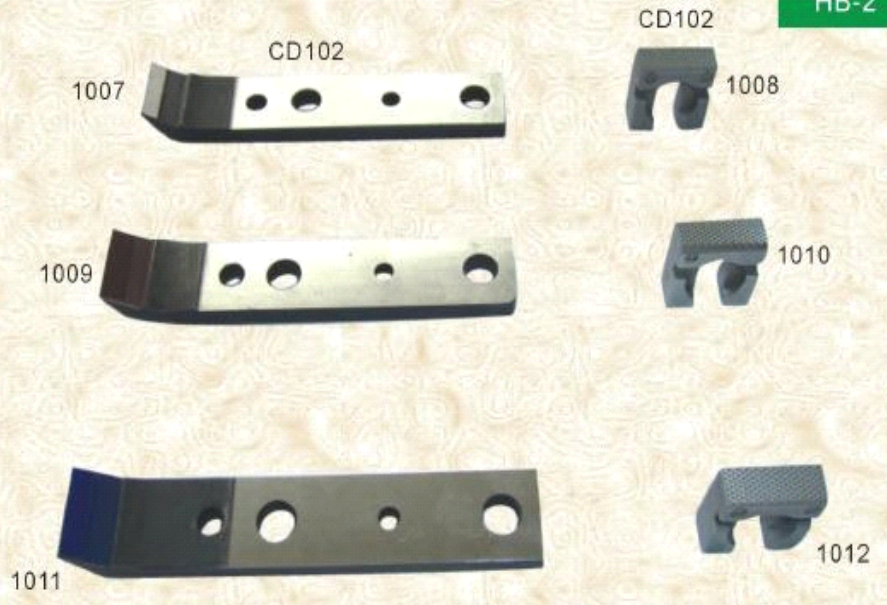

HB-3

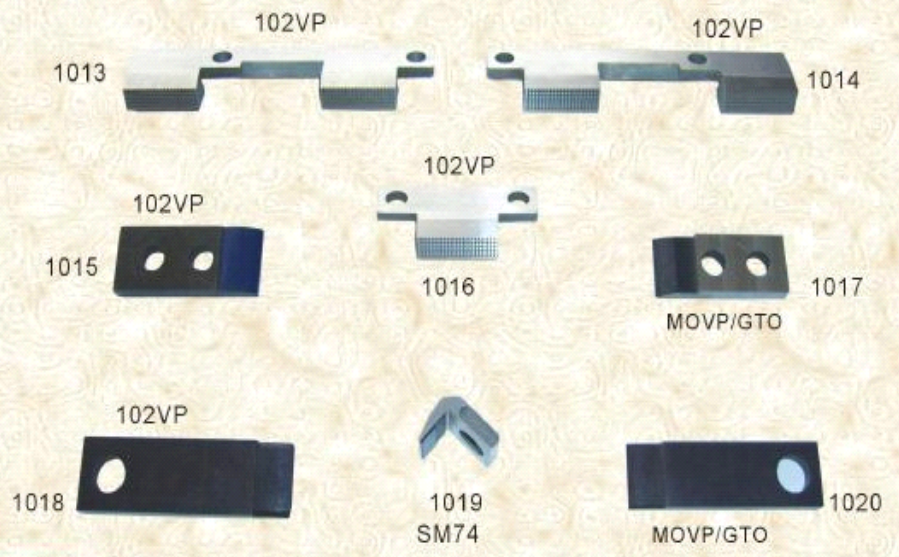

HB-4

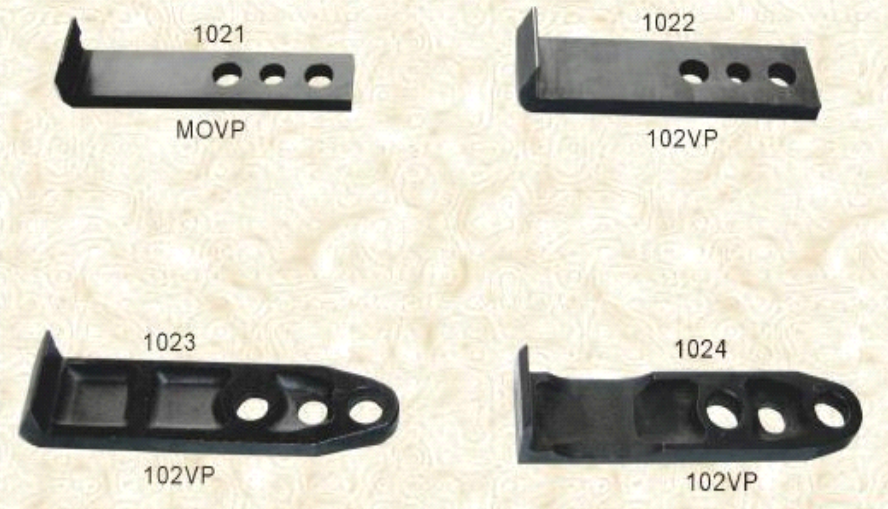

HB-5

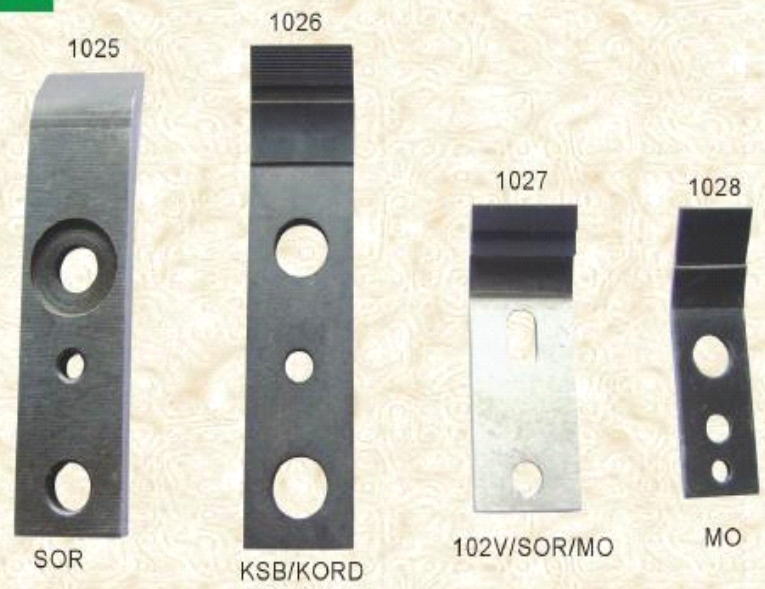

HB-6

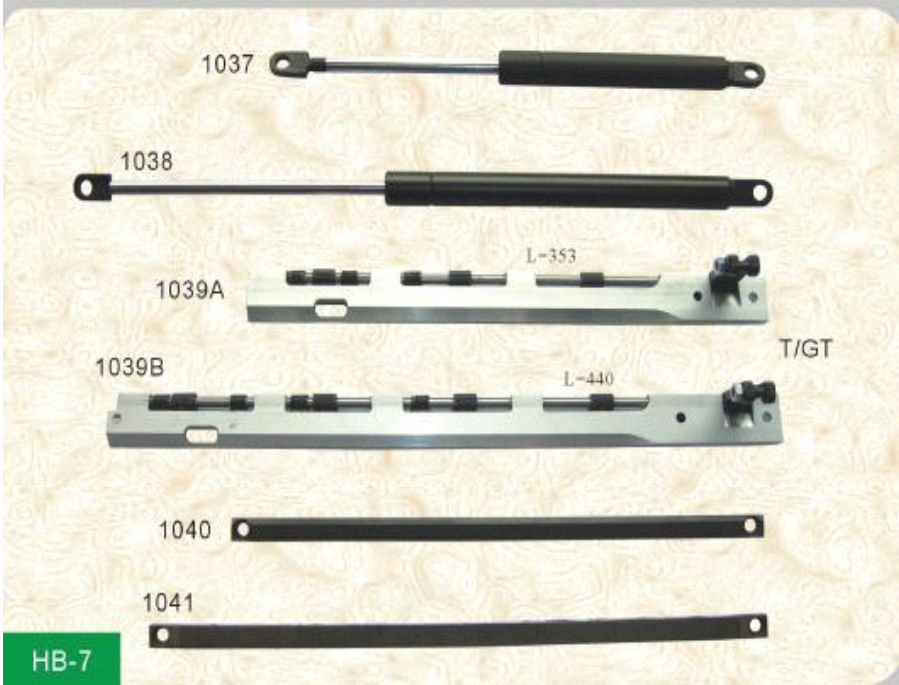
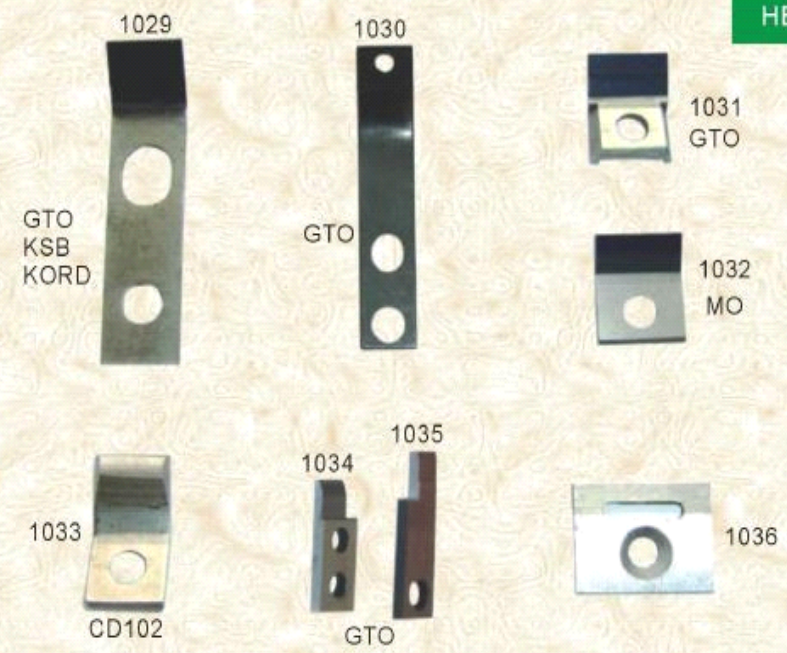

HB-7

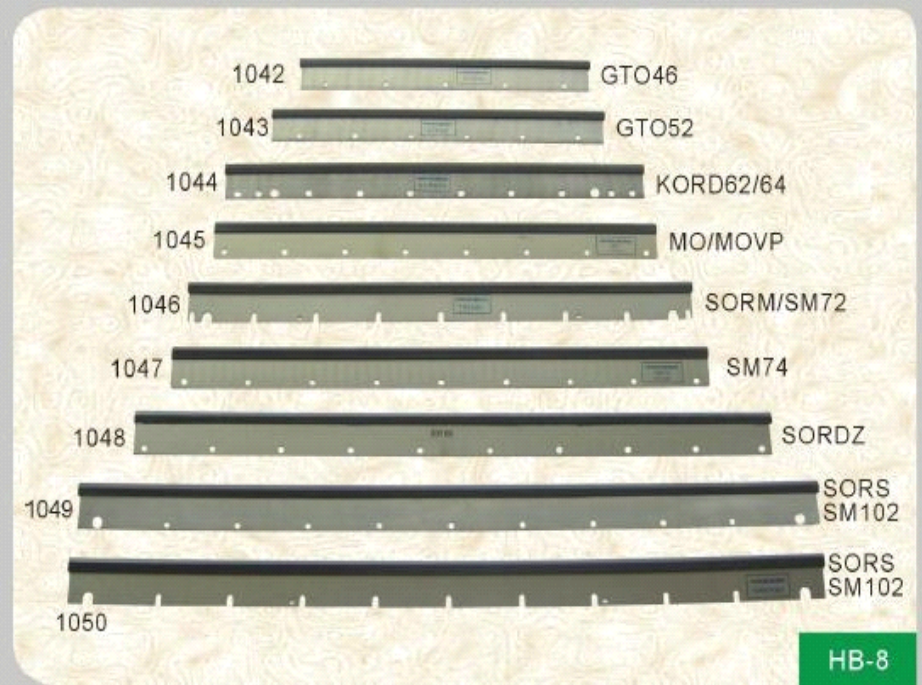

HB-8

HB-9



HB-10

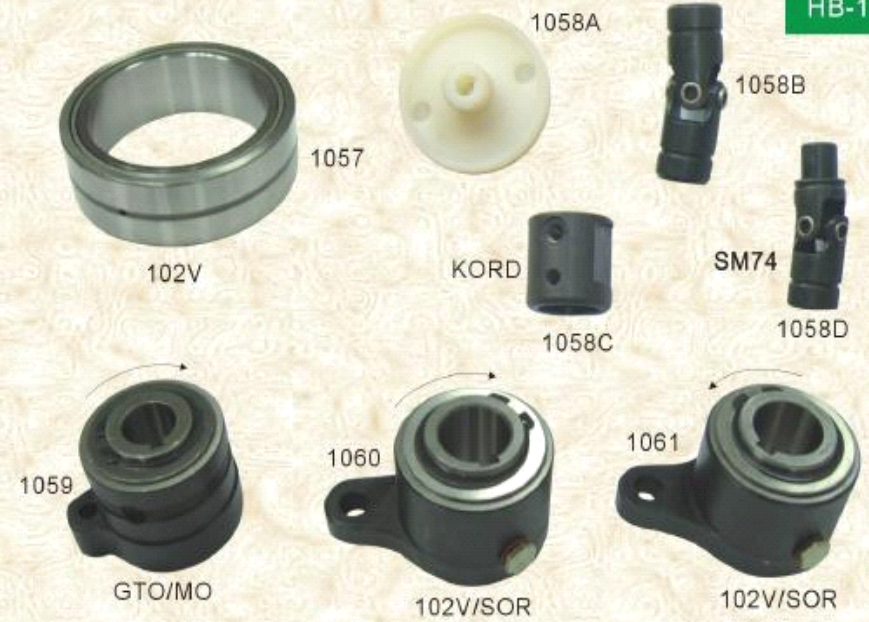

HB-11

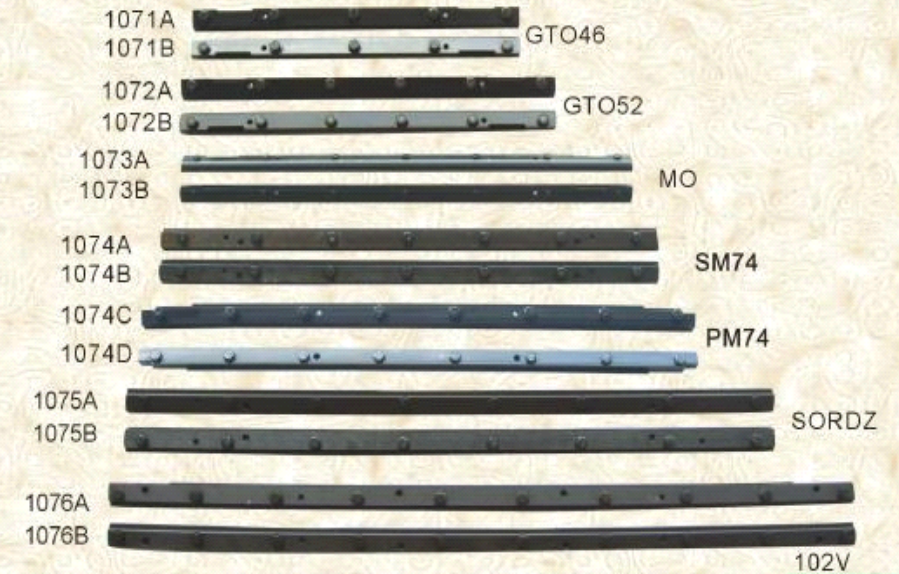
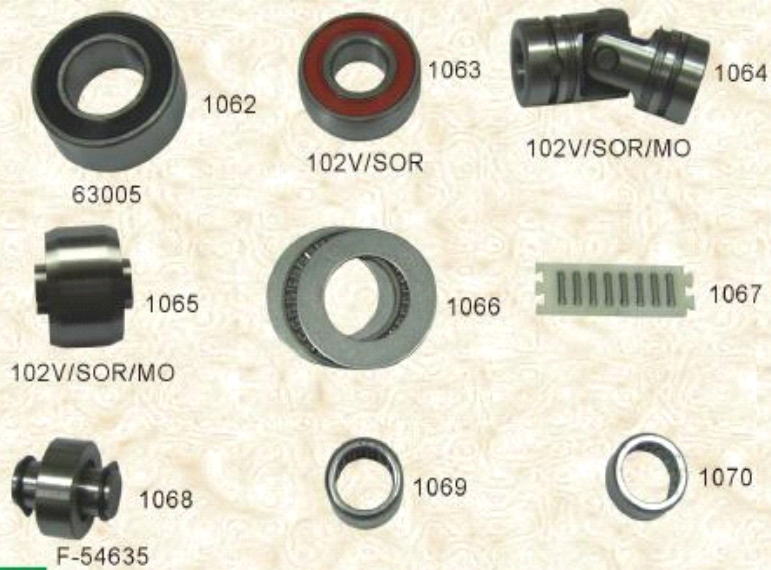

HB-12

HB-13



HB-14

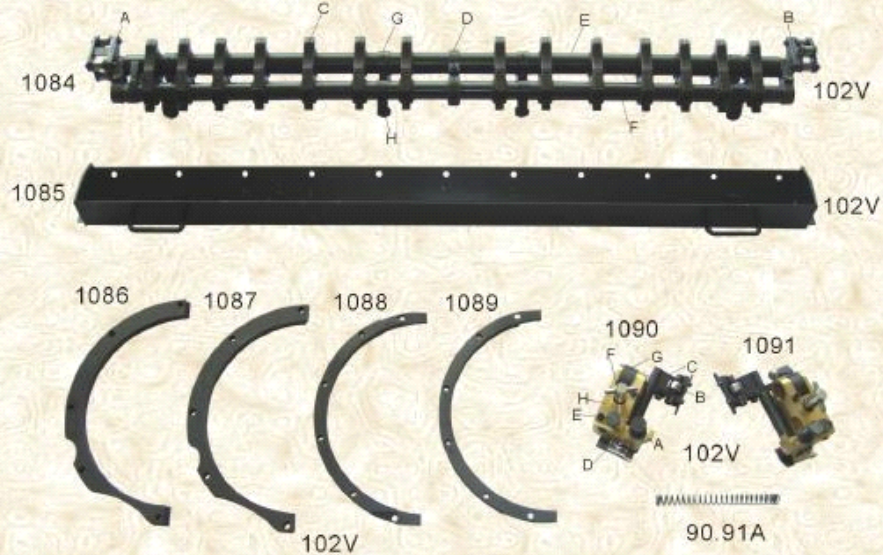

HB-15

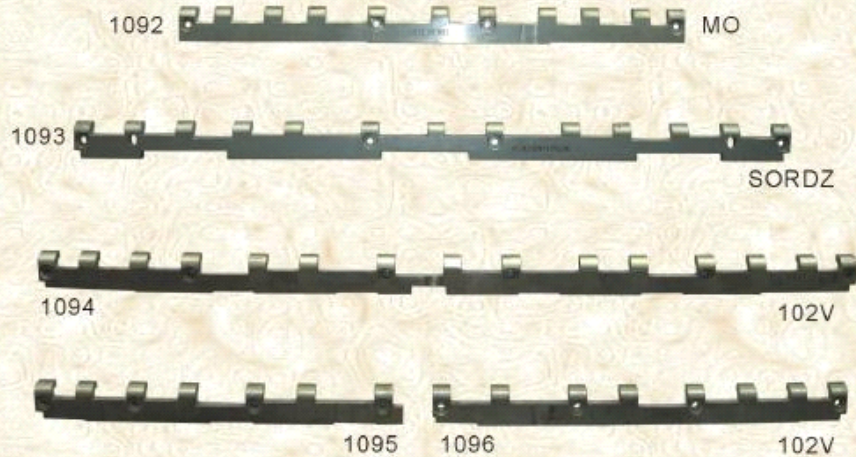

HB-16

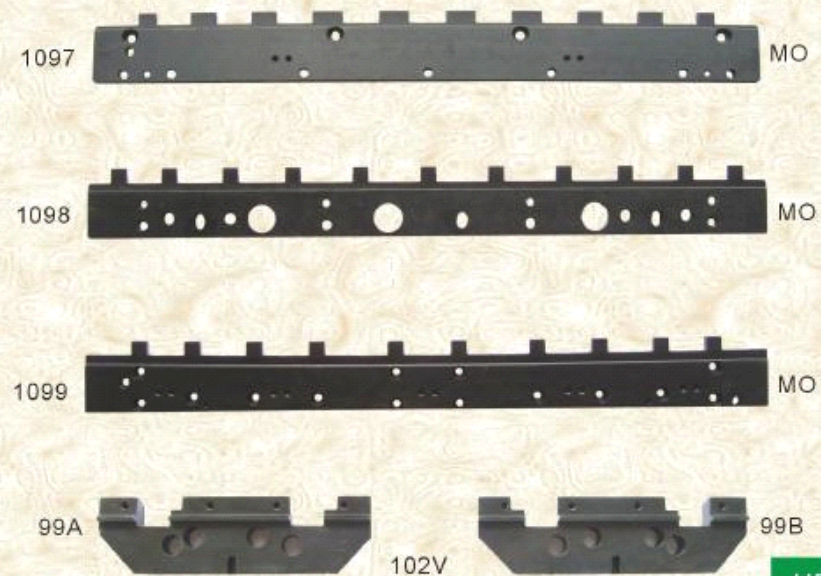

HB-17

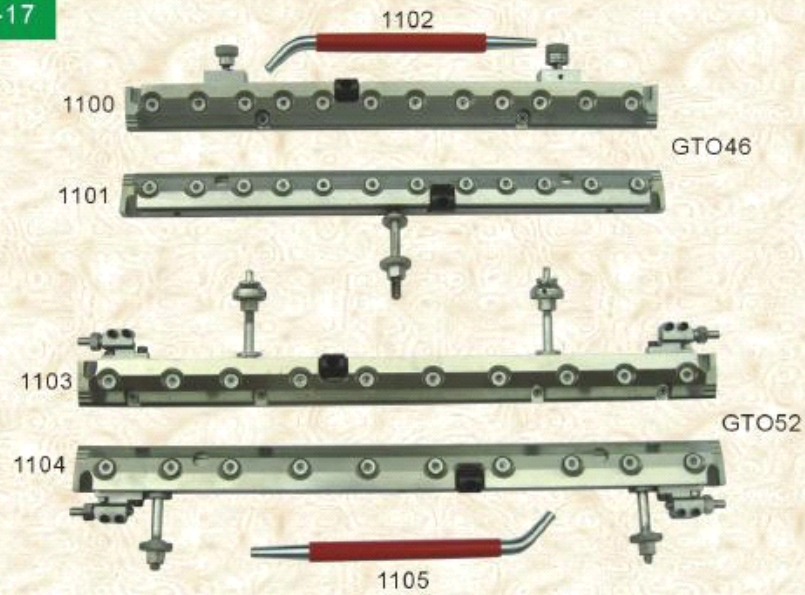

HB-18



HB-19

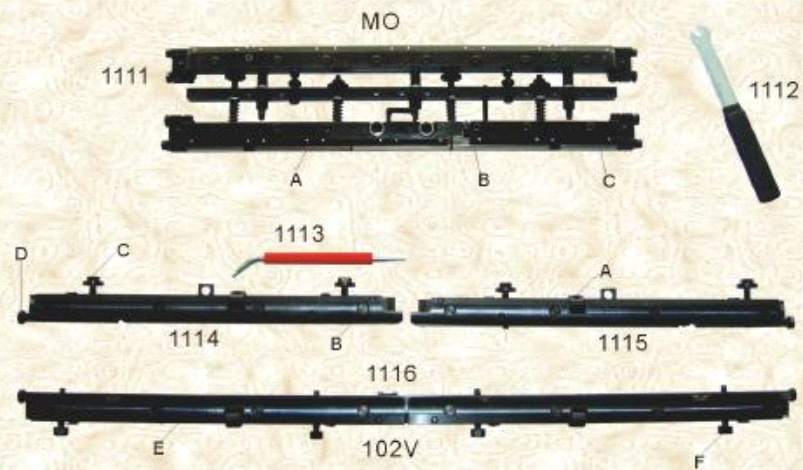

HB-20

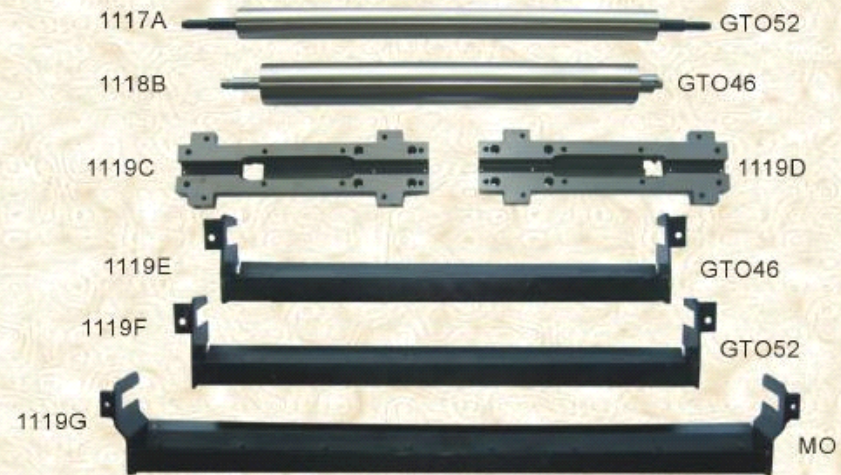

HB-21

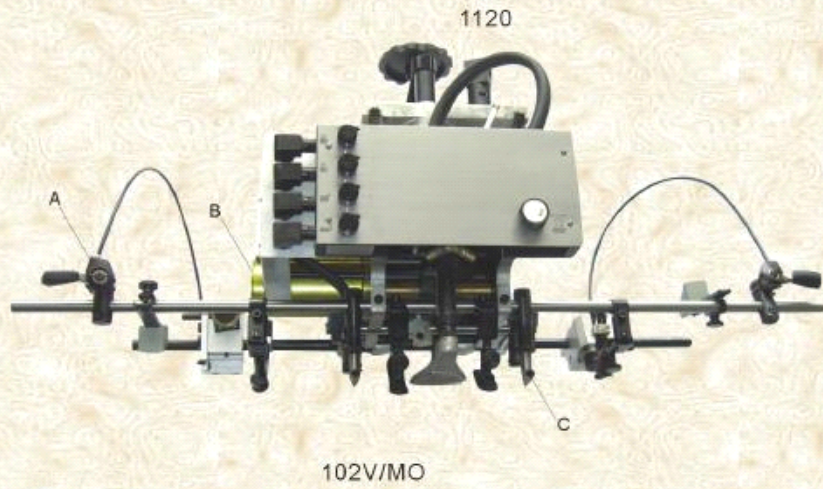

HB-22

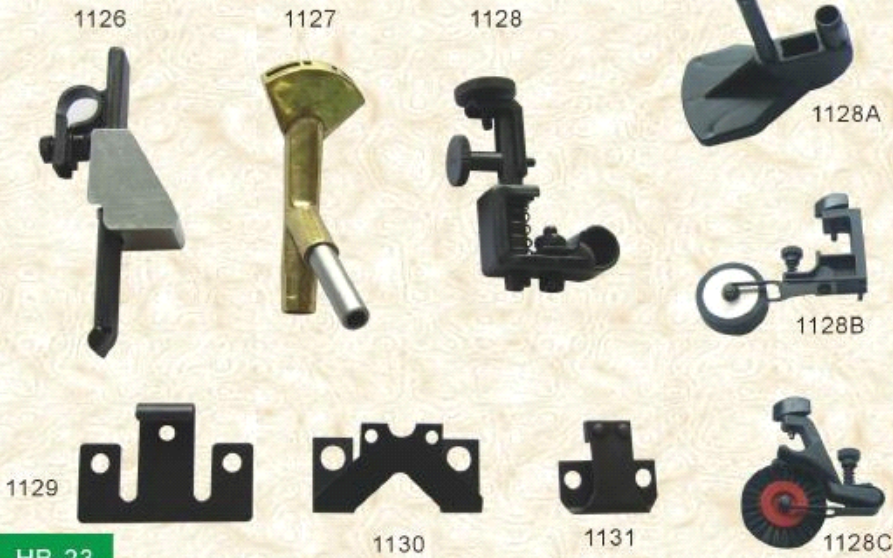
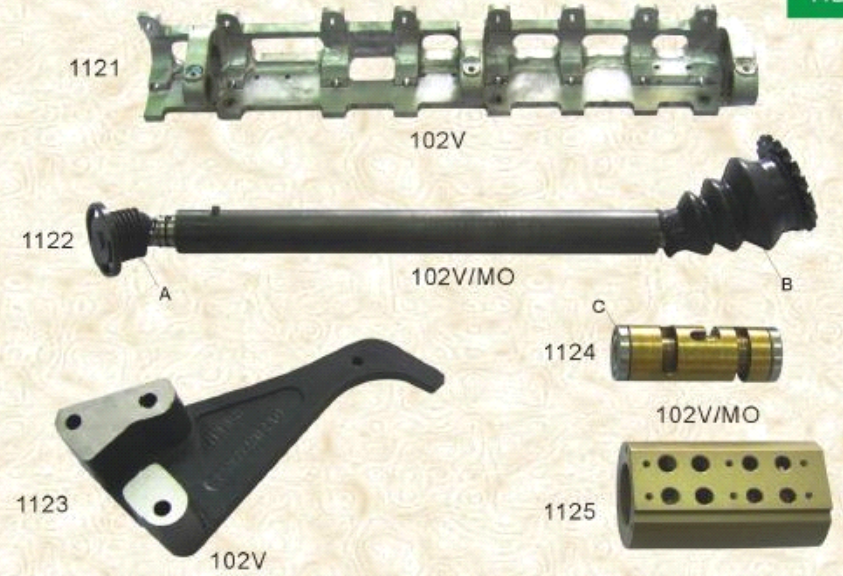

HB-23

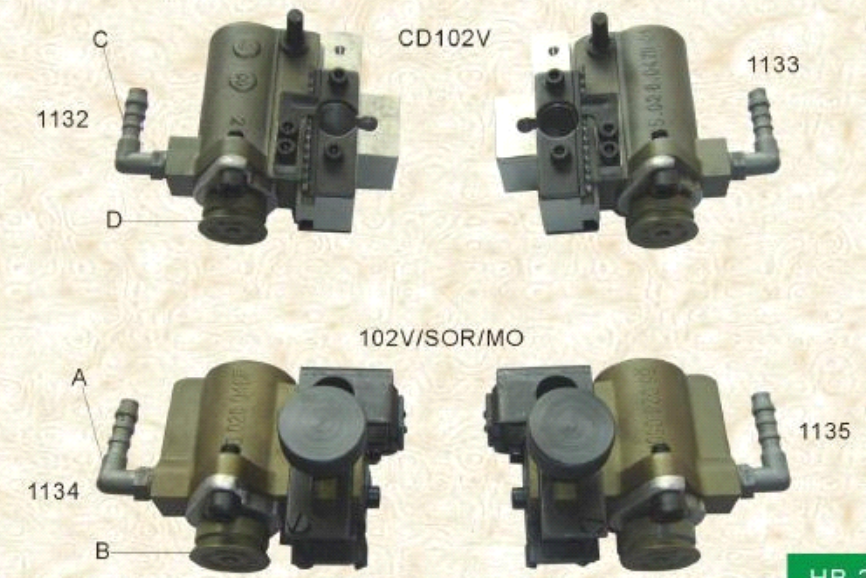

HB-24

HB-25



HB-26

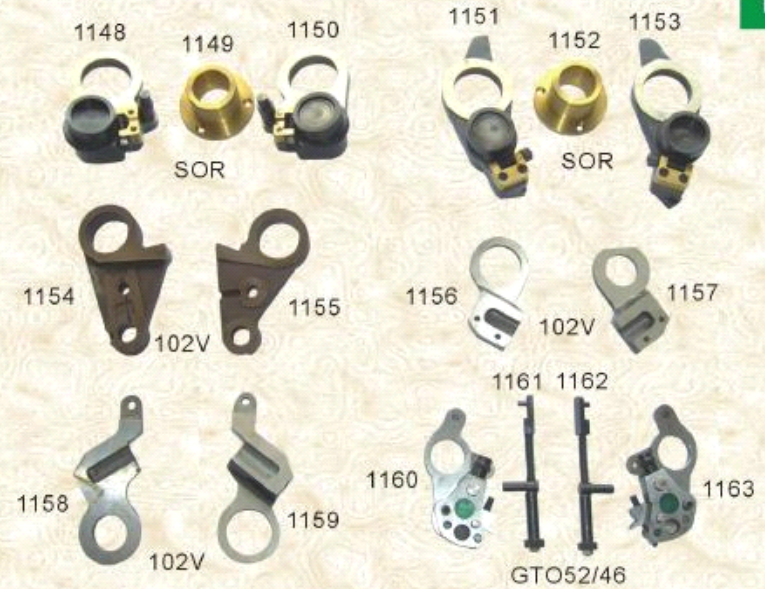

HB-27



HB-28

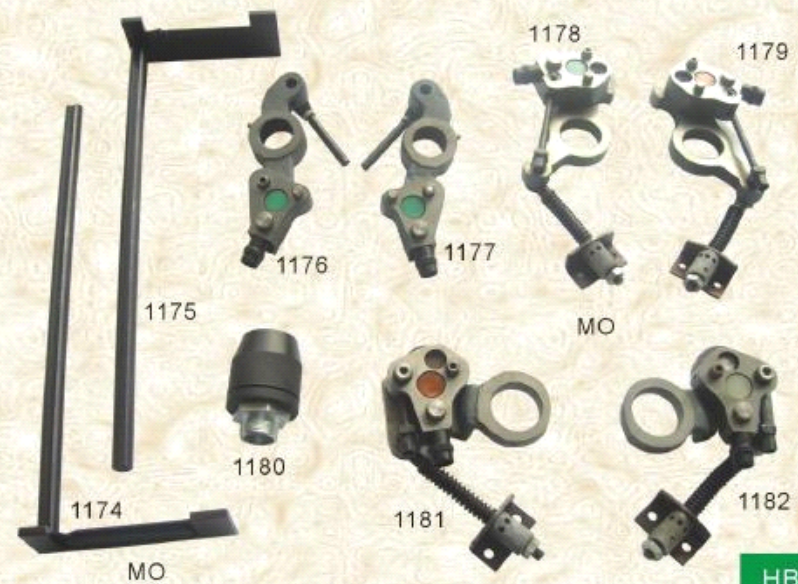

HB-29

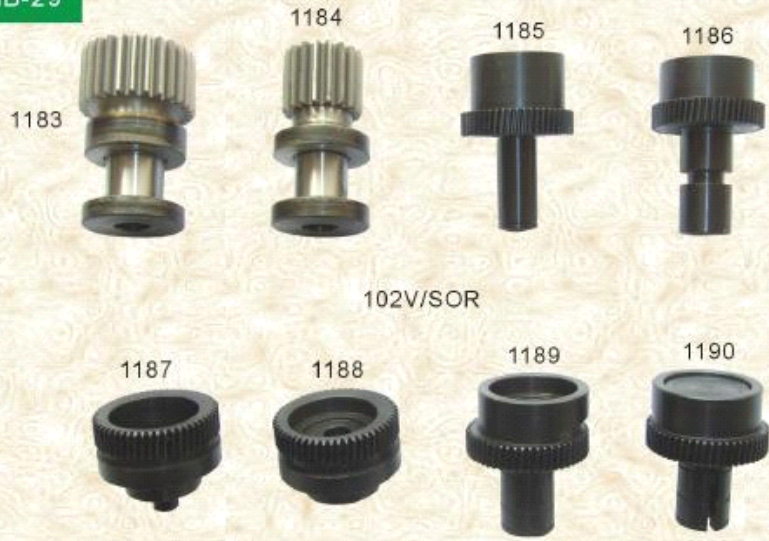

HB-30



HB-31

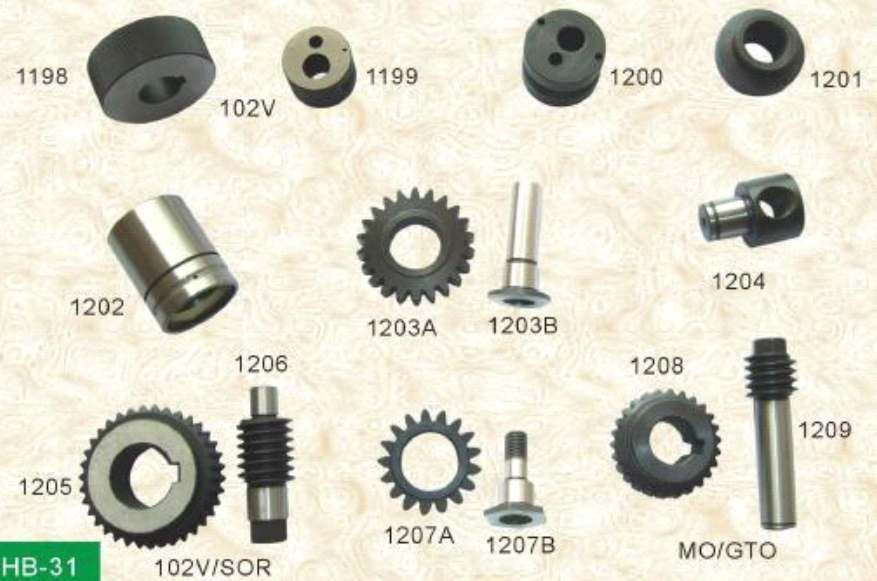

HB-32

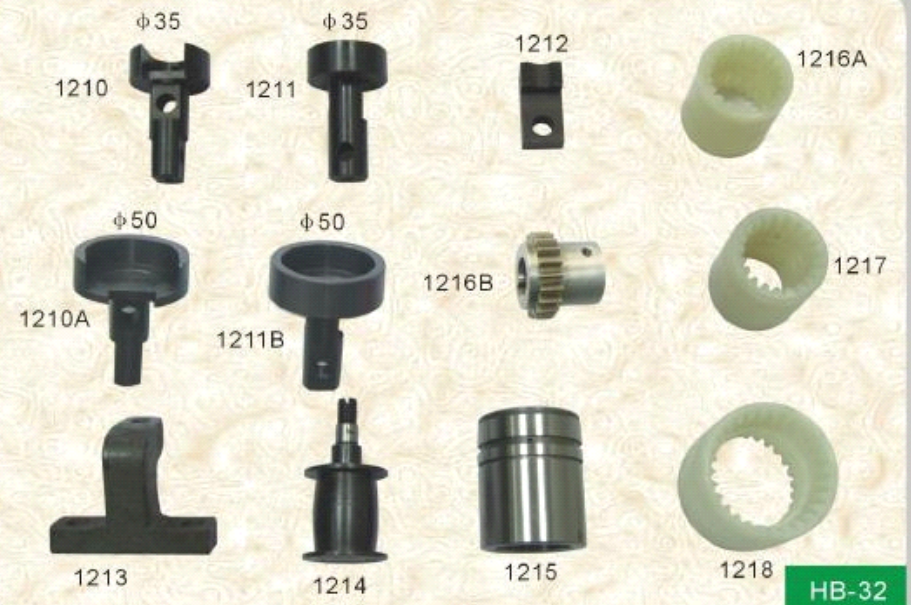

HB-33

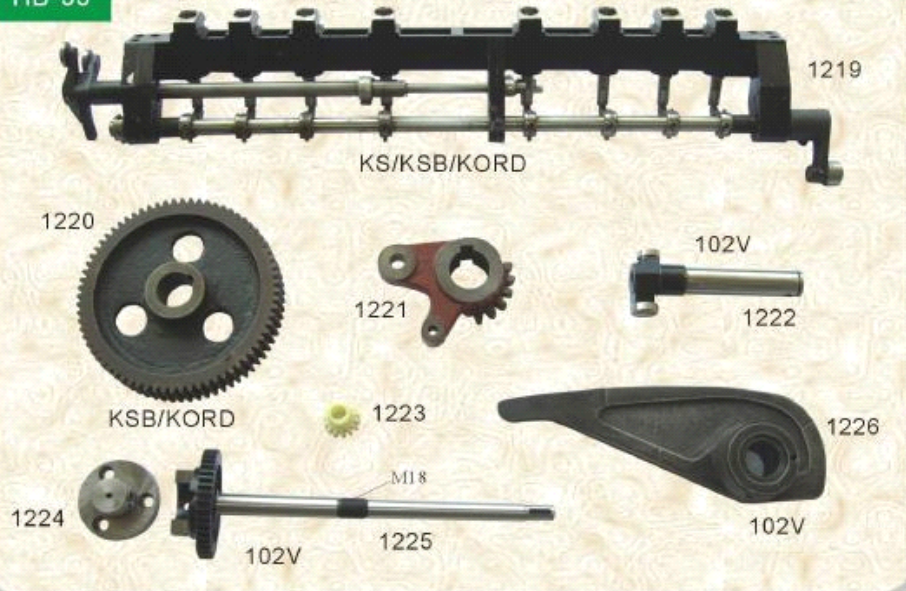

HB-34

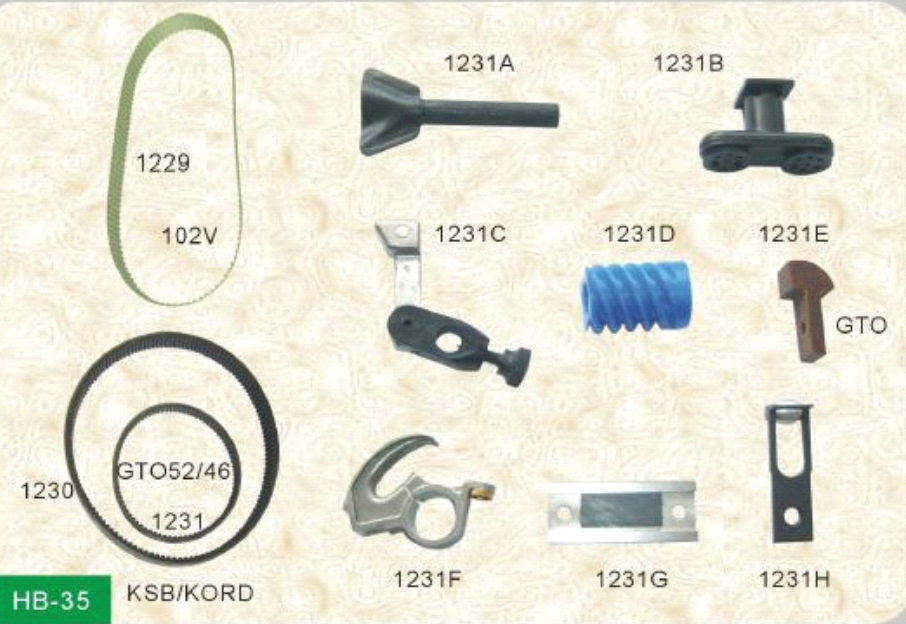
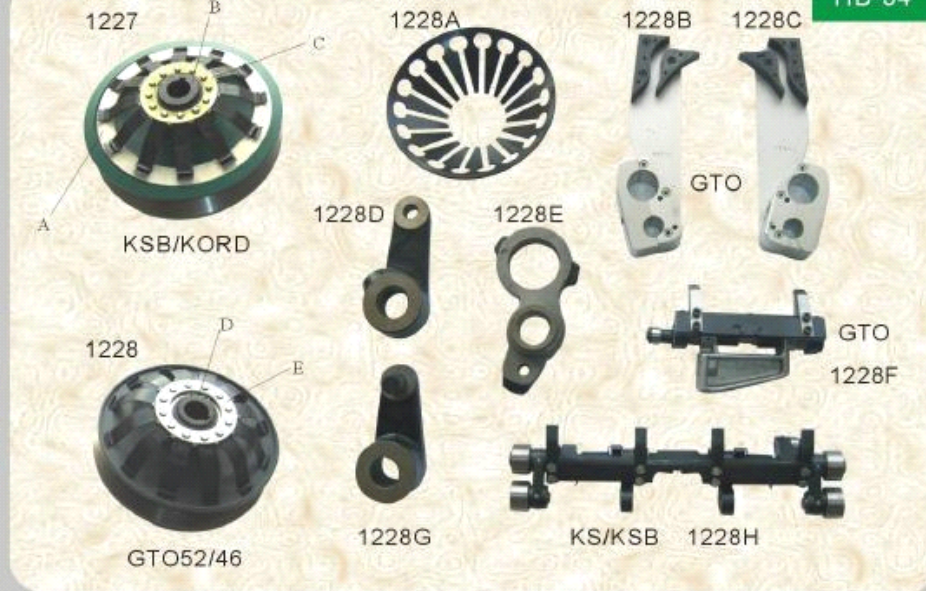

HB-35



HB-36

HB-37

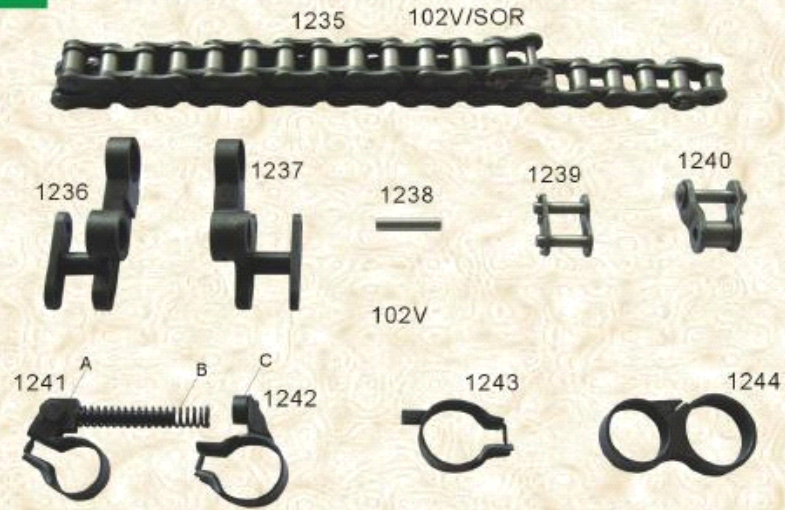

HB-38



HB-39

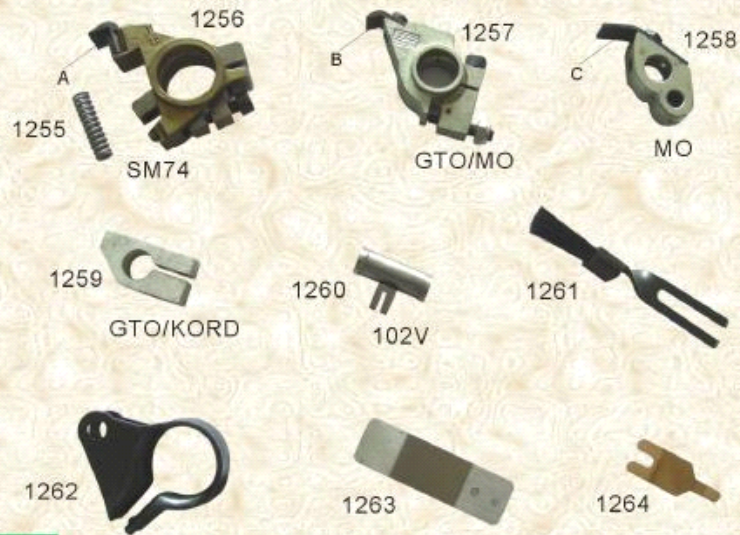

HB-40



HB-41

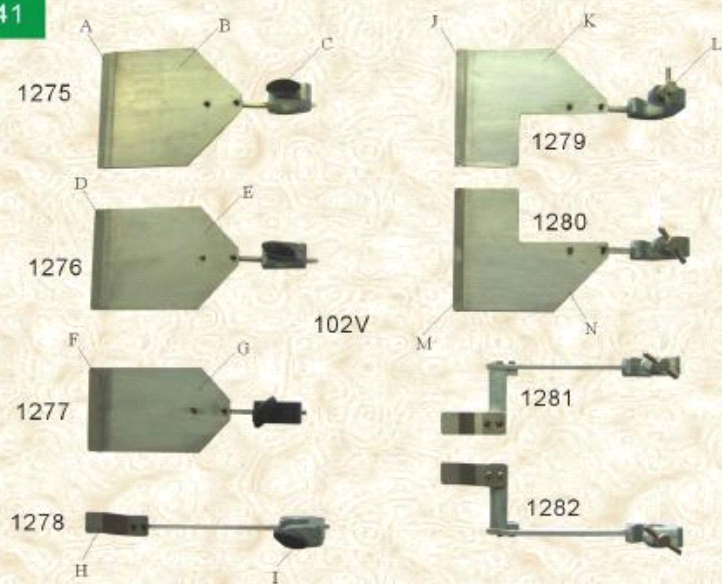

HB-42

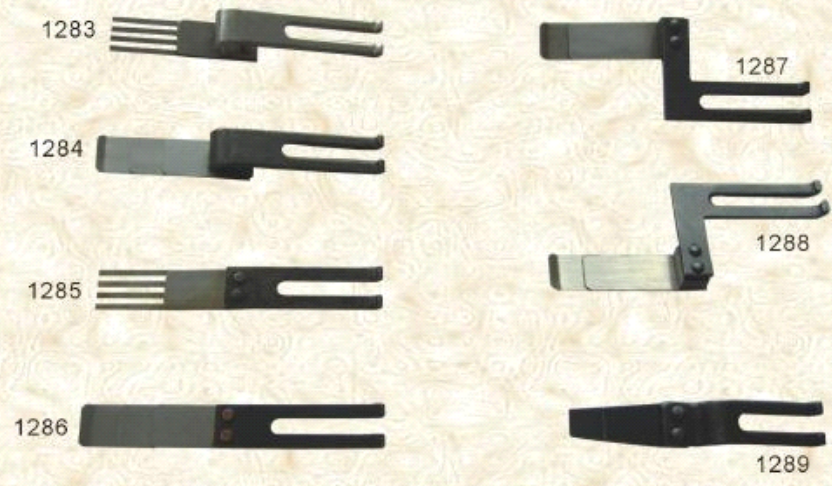

HB-43



HB-44

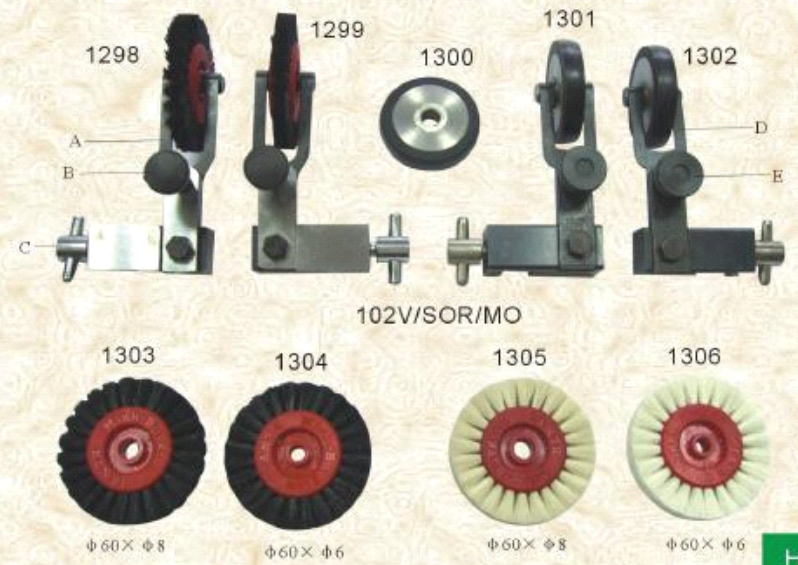

HB-45

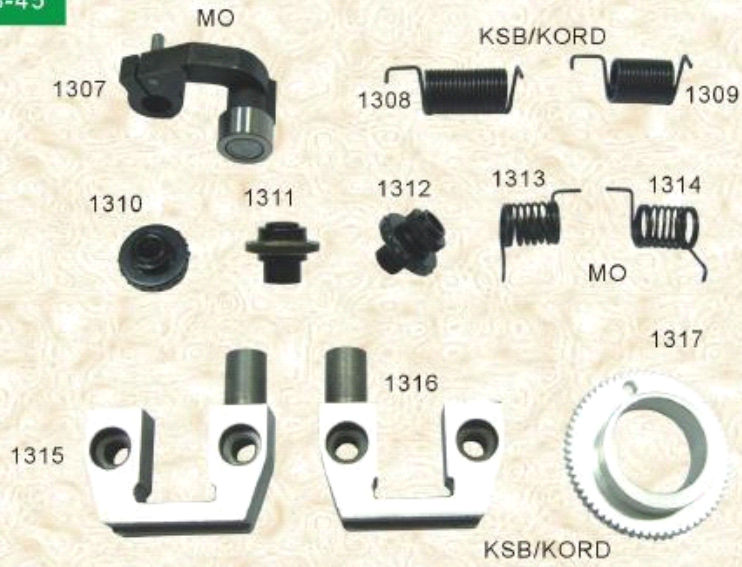

HB-46

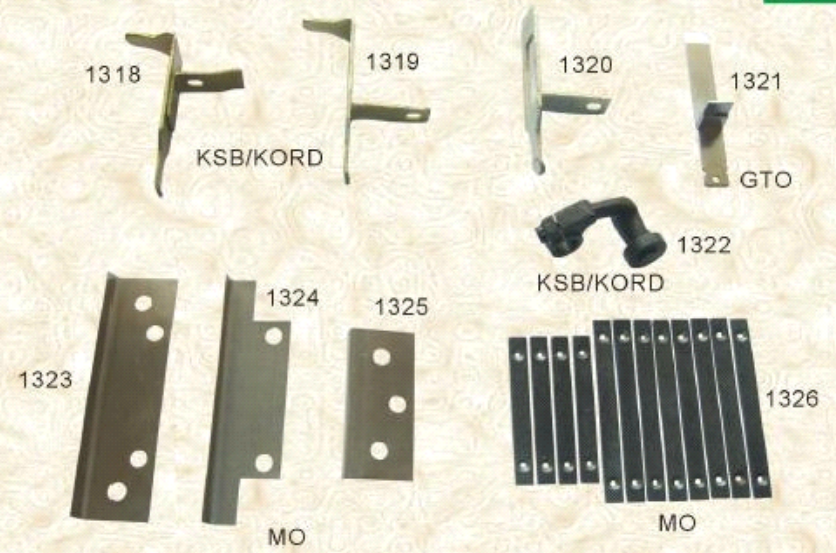

HB-47

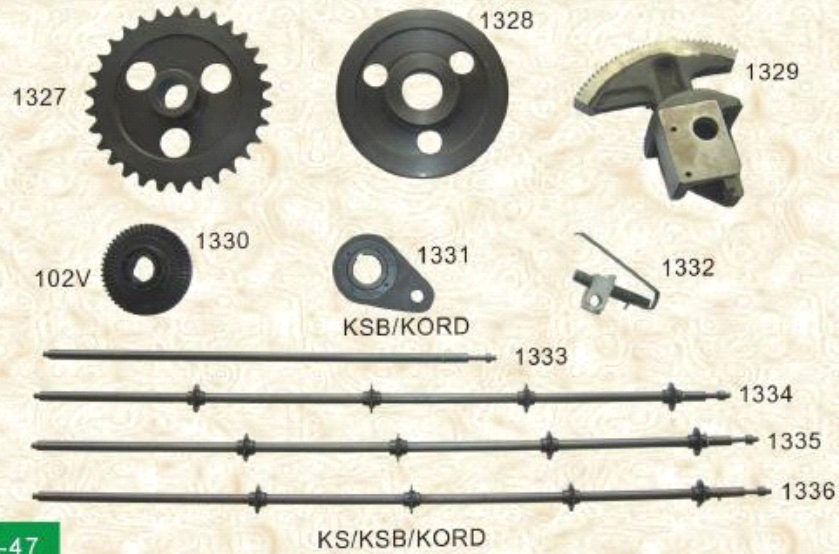

GTO46



HB-48

HB-49



HB-50

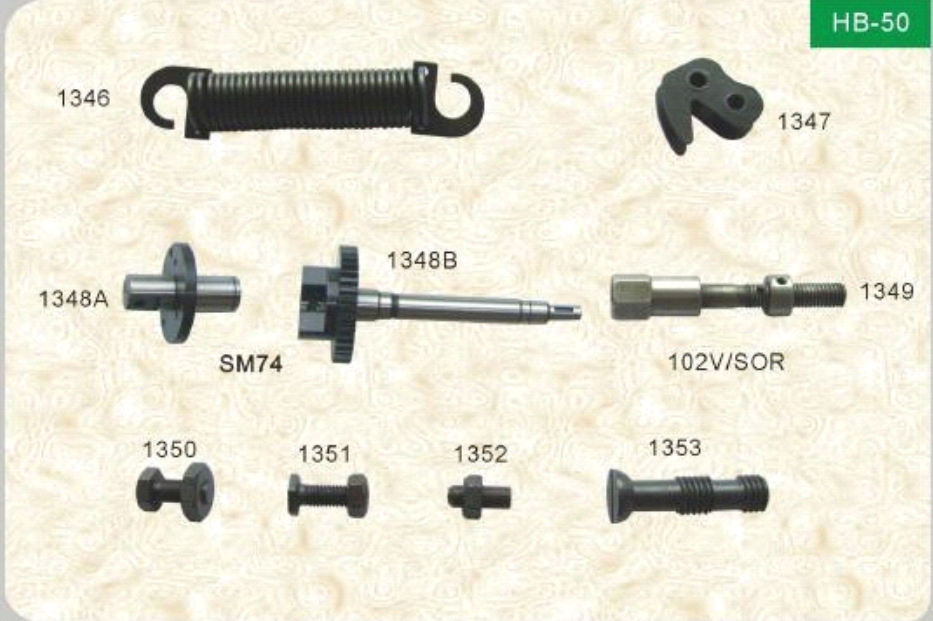

HB-51

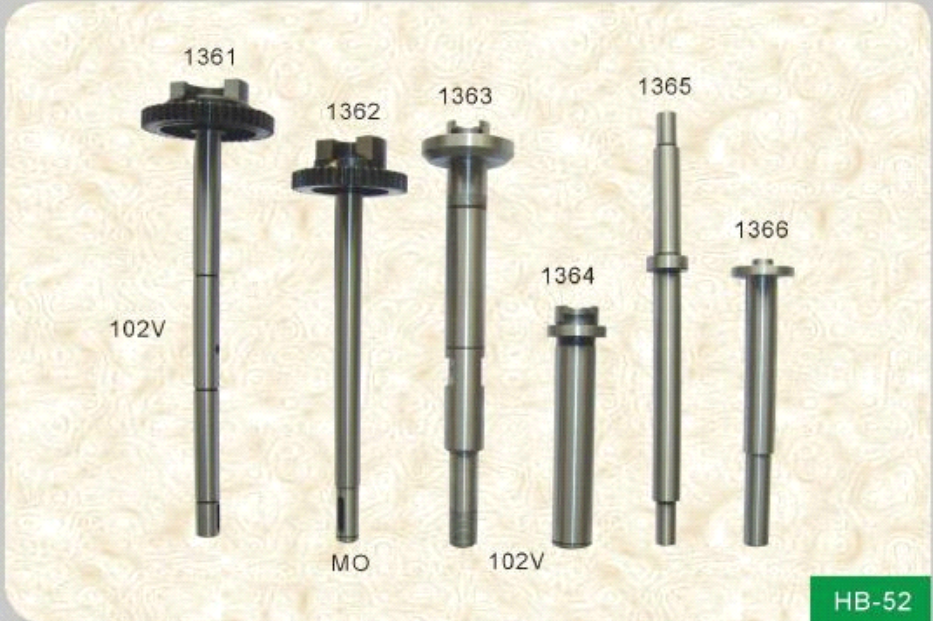

HB-52

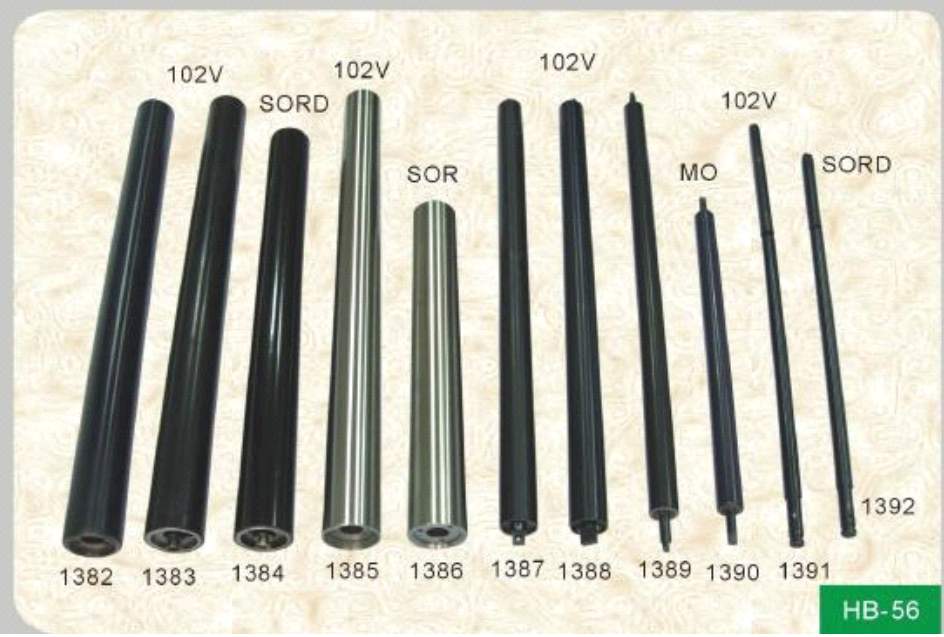
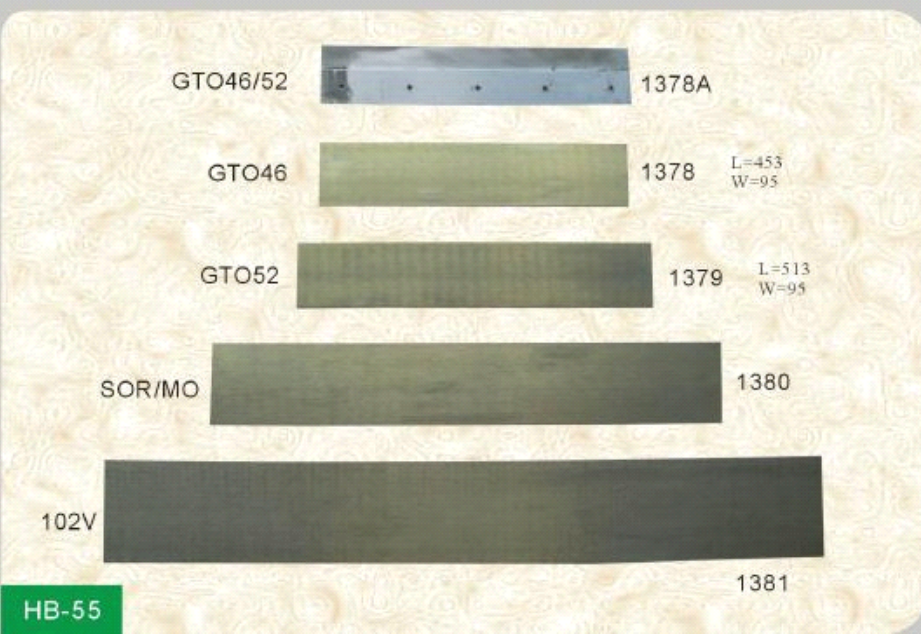
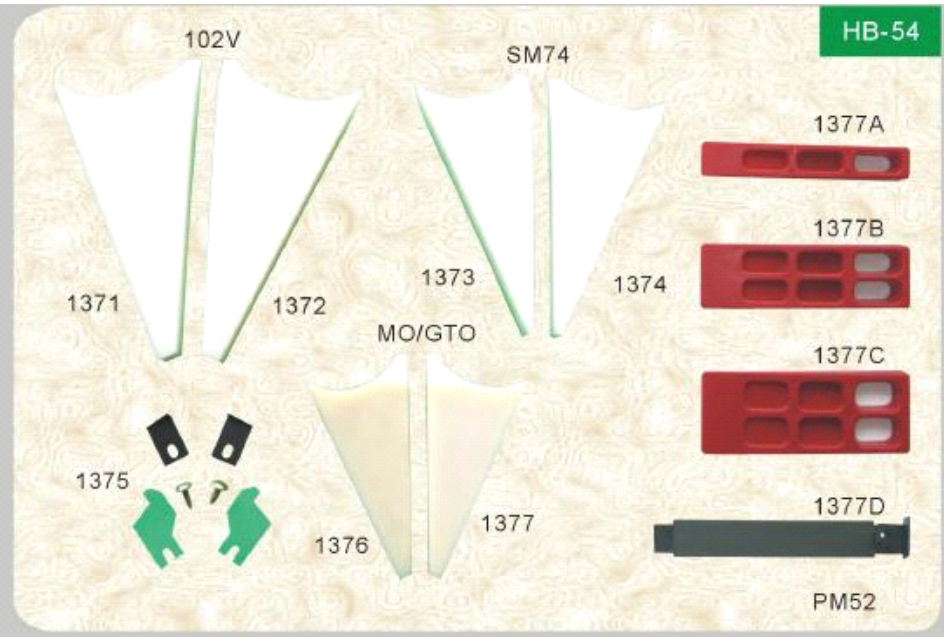

HB-57

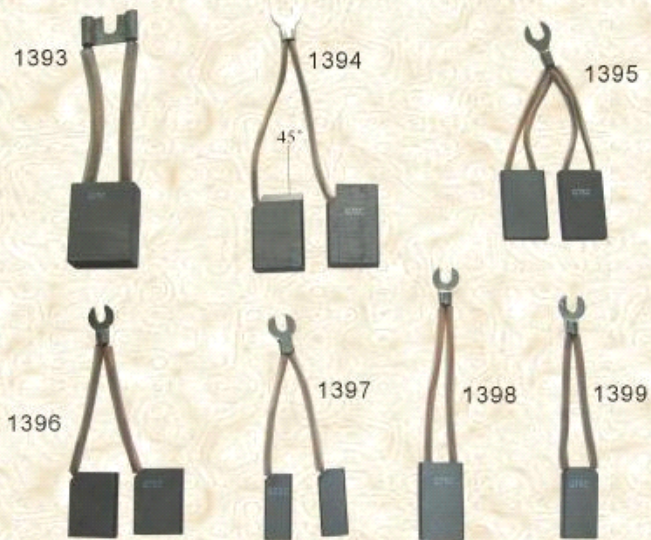

HB-58

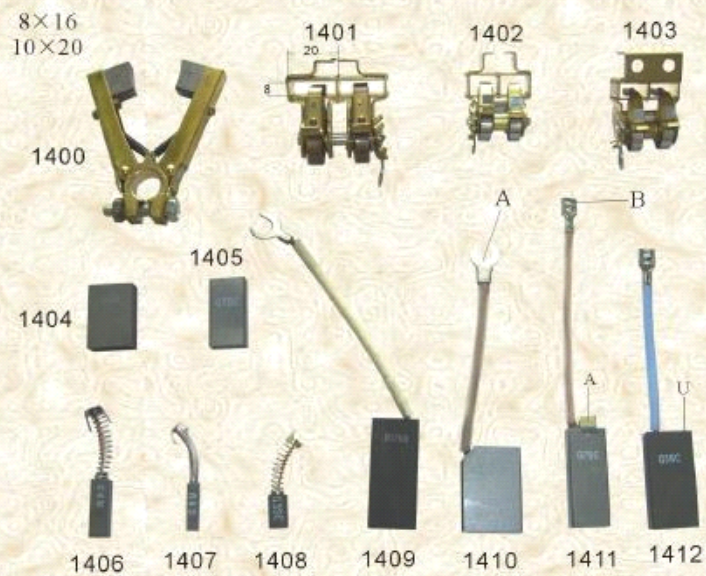

HB-59

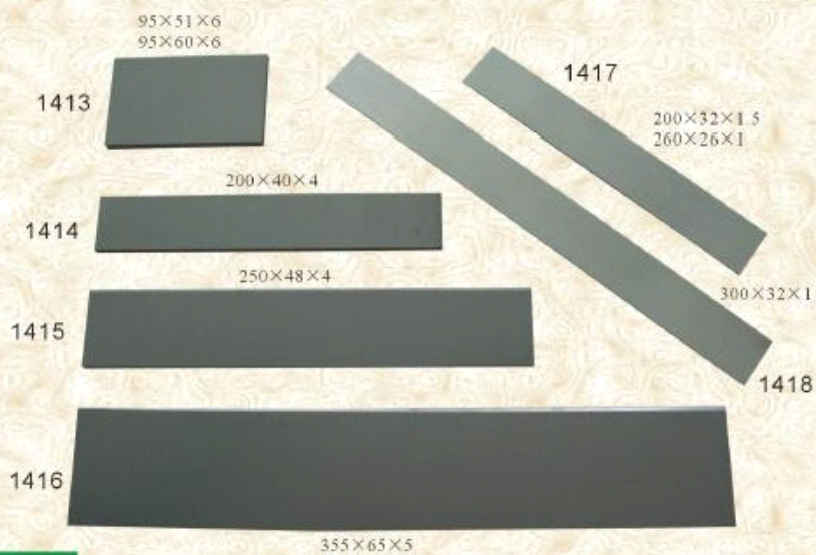

HB-60

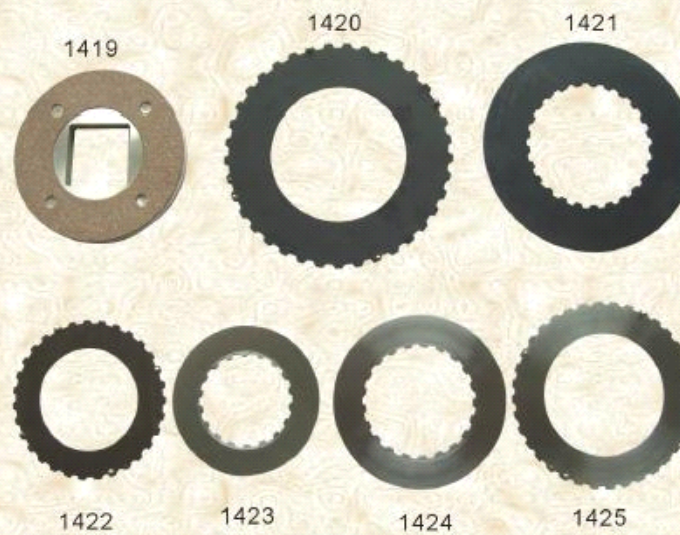

HB-61

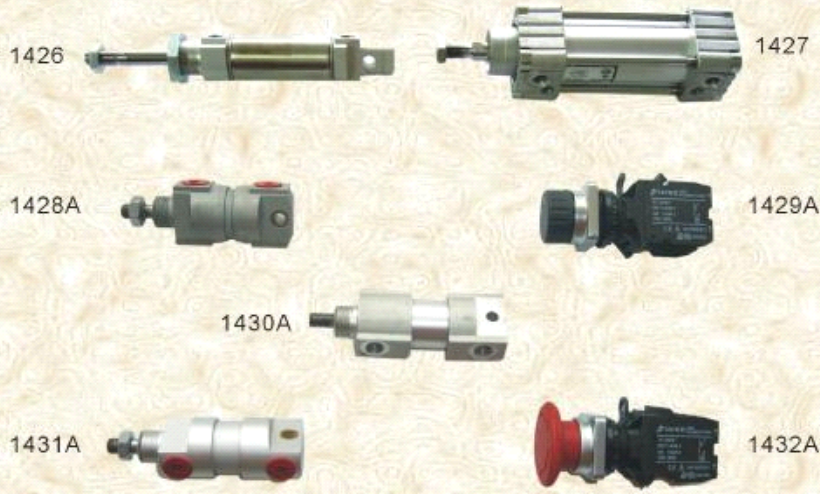

HB-62

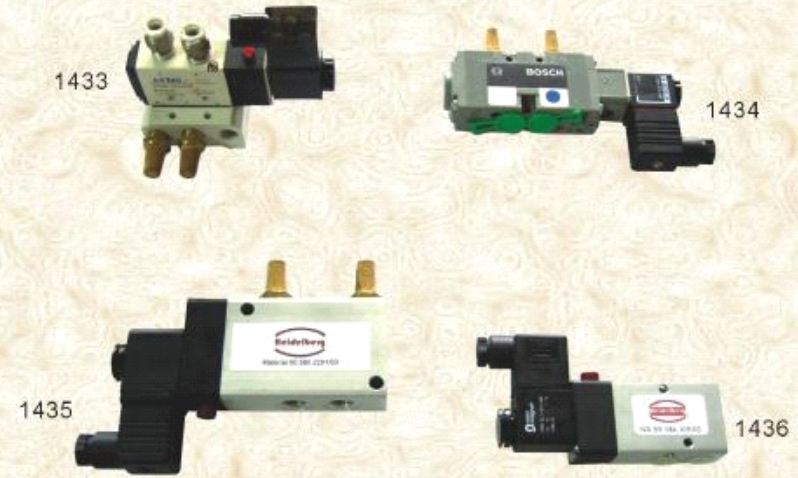

HB-63



HB-64

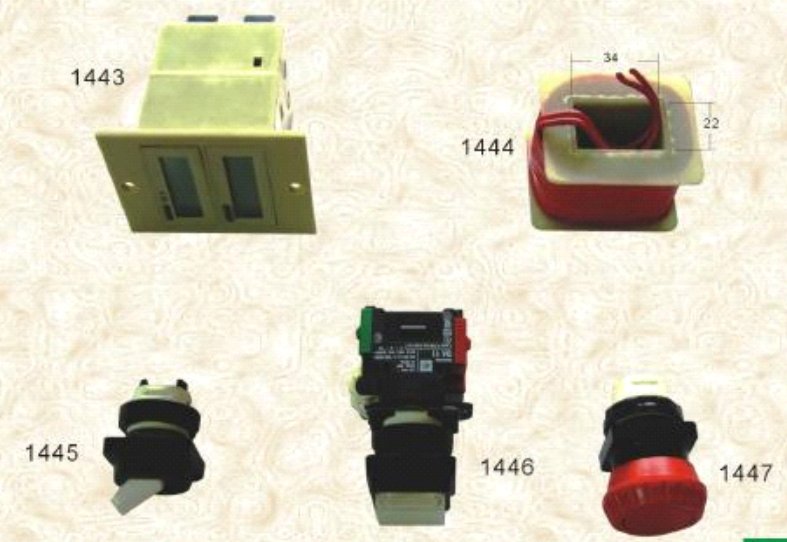

HB-65

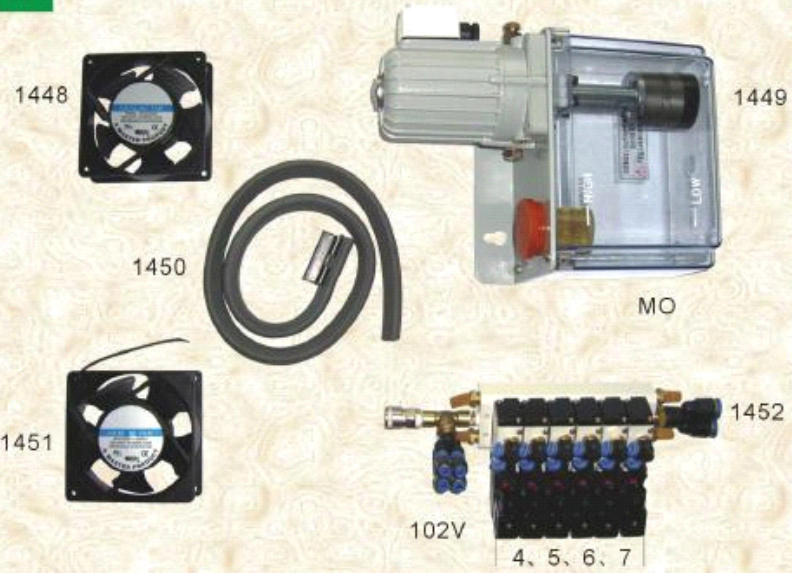

HB-66



HB-67



HB-68



HB-69

1471

1.2×25
1.5×25
1×28



1472



0.8×25
0.8×28



1473



1474



1475

HB-70

1476A



1477



1478



1479

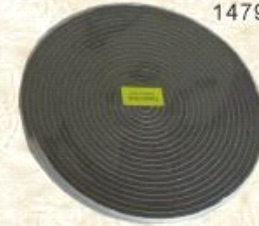

1476B



1480



102V

L-1000

1481



320#, 180#

1150mm×20m

HB-71

1482

70mm×25m



1483



1484



102V



1485



1486

HB-72

HB-73

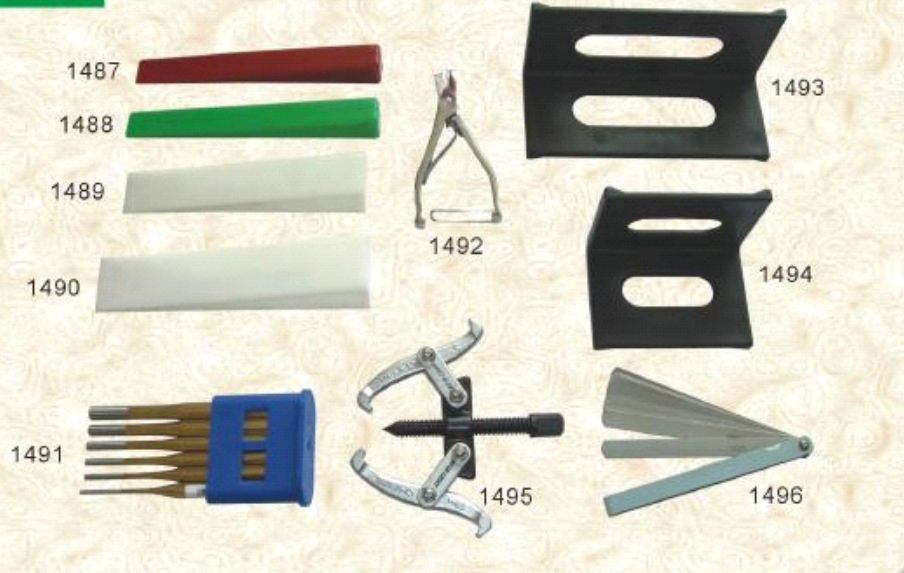

HB-74



HB-75

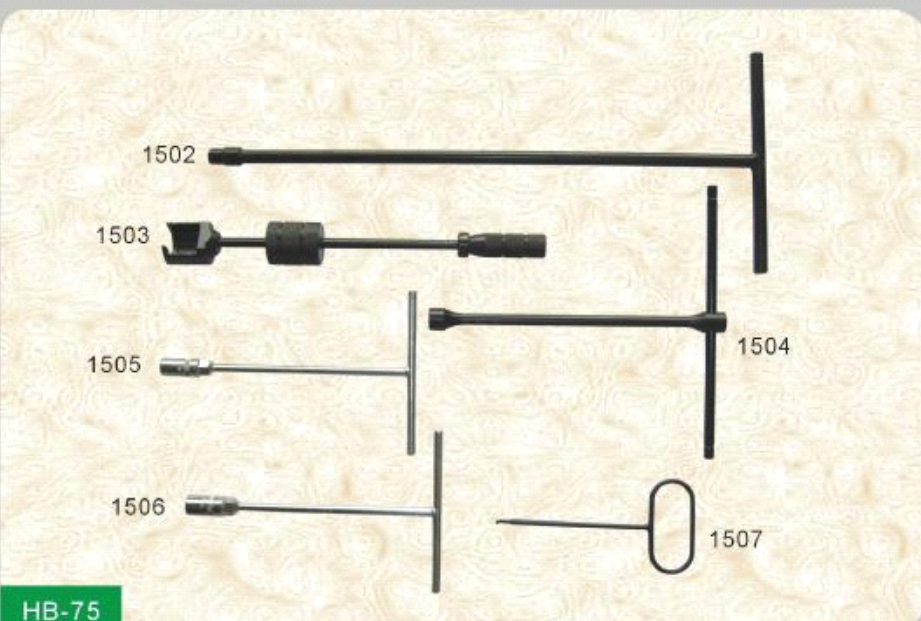

HB-76

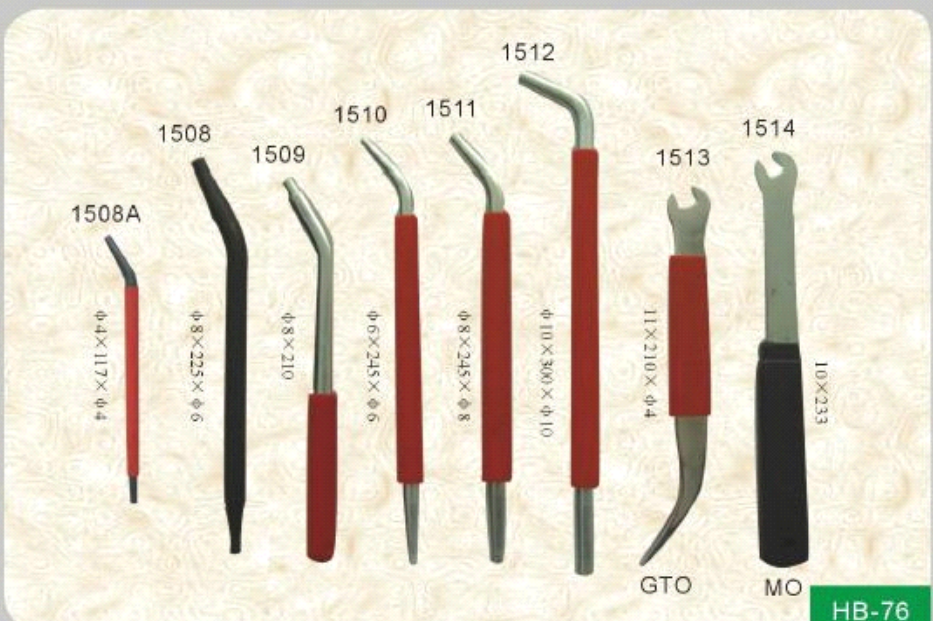

HB-77

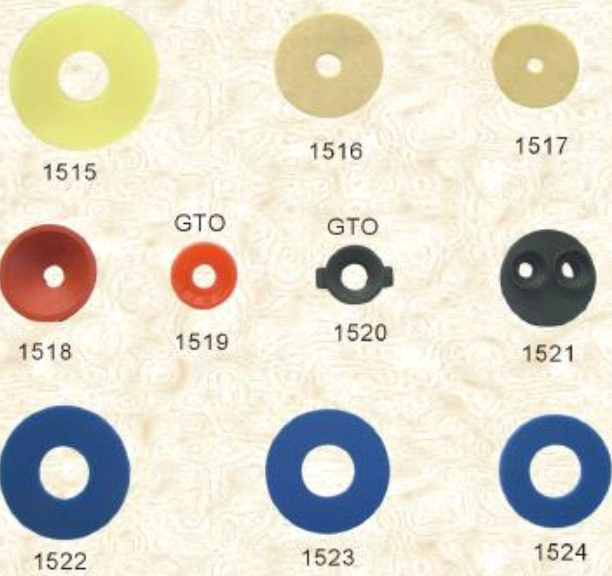

HB-78



1533

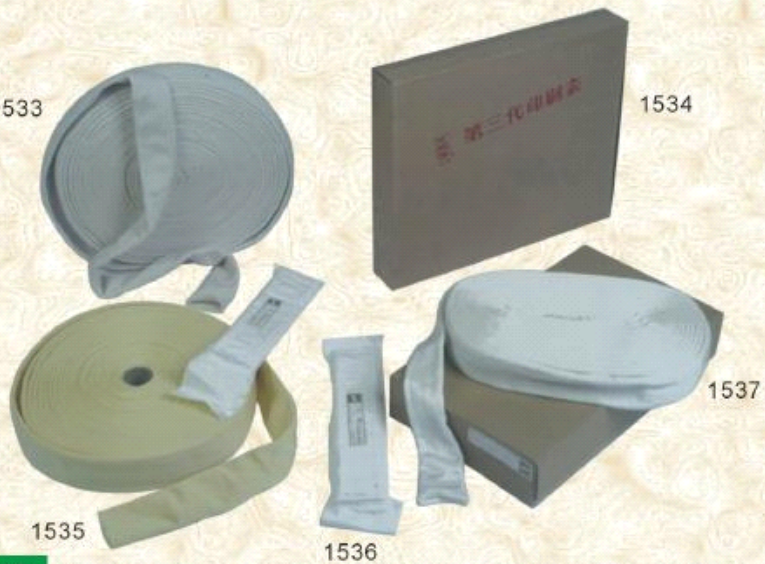

HB-79



HB-80